



Threshold Detector

10 to 2000 MHz

Technical Data

UTD-2002

Features

- Externally Set Threshold
- TTL Output
- Low VSWR
- 20 dB Threshold Range

Applications

- Specifically Designed for System Built-in Test
- Built for Retrofitting
- Channel RF Activity Monitoring

Description

The UTD-2002 is a sensitive microwave threshold detector which provides efficient and accurate RF level measurement at critical system points. It contains a Schottky diode detector, comparator, and a temperature compensated voltage reference assembly. The unit is built with chip and wire construction, on a thin-film substrate for small size and ruggedness.

Pin Configuration TO-8F

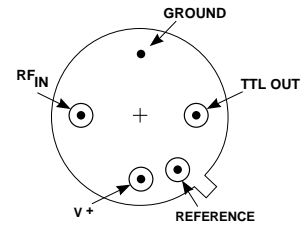

Maximum Ratings

Parameter	Maximum
DC Voltage	+17 V
Continuous RF Input Power	+15.0 dBm
Operating Case Temperature	-55°C to +125°C
Storage Temperature	-62°C to +150°C
“R” Series Burn-In Temperature	+125°C
DC Voltage Reference	+12 V

Weight: (typical) 2.1 grams

Electrical Specifications

(Measured in 50 Ω system @ +15 VDC nominal unless otherwise noted)

Symbol	Characteristic	Typical $T_C = 25^\circ\text{C}$	Guaranteed Specifications		Unit
			$T_C = 0 \text{ to } 50^\circ\text{C}$	$T_C = -55 \text{ to } +85^\circ\text{C}$	
—	Frequency (Min.)	10-2000	10-2000	10-2000	MHz
—	Input Flatness (Max.), $P_{IN} = -10 \text{ to } +10 \text{ dBm}$	± 0.5	± 0.7	± 1.0	dB
—	Input Operating Range	-10 to +10	-10 to +10	-10 to +10	dBm
—	Input VSWR (Max.)	1.3:1	1.7:1	2.0:1	—
—	Threshold Temperature Stability (Max.)				
	@ -10 dBm Input Power	—	± 1.0	± 1.5	dB
	@ 0 dBm Input Power	—	± 0.7	± 1.0	dB
	@ +10 dBm Input Power	—	± 0.5	± 0.7	dB
—	Threshold Control Voltage/Resistance				
	@ -10 dBm Input Power	90 mV/300 Ω	—	—	Ω
	@ 0 dBm Input Power	280 mV/900 Ω	—	—	Ω
	@ +10 dBm Input Power	900 mV/2900 Ω	—	—	Ω
—	Threshold Hysteresis (Max.)				
	Resistance Control	1.0	—	—	dB
	Voltage Control	0.1	—	—	dB
—	Control Terminal Current	0.3	—	—	mA
—	Output Compatibility	TTL	TTL	TTL	—
—	Output at P_{IN} Threshold (Min.)	2.7	2.7	2.7	V
—	Output Short Circuit Current (Min.)	3.0	3.0	3.0	mA
—	Output Sink Current (Min.), $V_0 = 0.7 \text{ V}$	2.0	2.0	2.0	mA
—	Output for Input Power Change > 3 dB above CW Threshold				
	$C_L = 15 \text{ pF}$	—	—	—	—
	Rise Time	30	—	—	ns
	Fall Time	80	—	—	ns
	Propagation Delay	1000	—	—	ns
—	Supply Voltage				
	As Specified	+15	—	—	VDC
	Operational	+11 to +16	—	—	VDC
—	Supply Current @ +15 Volts	12	15	15	mA

Typical Performance @ 25°C

Key: +25°C ———
 +85°C - - - -
 -55°C = = = =

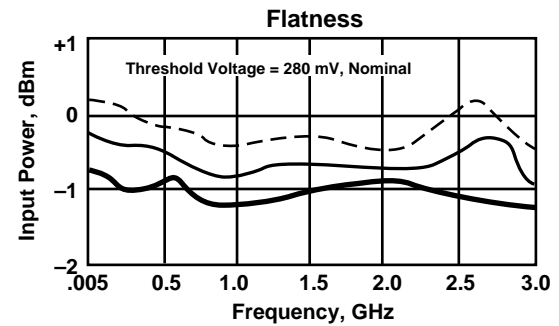
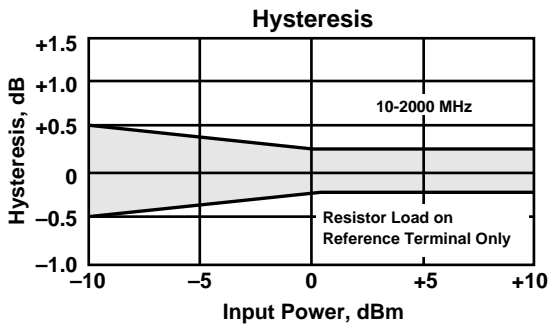
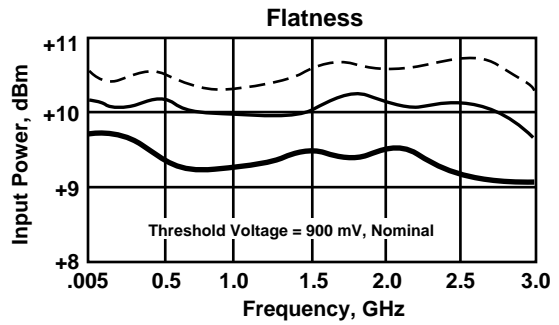
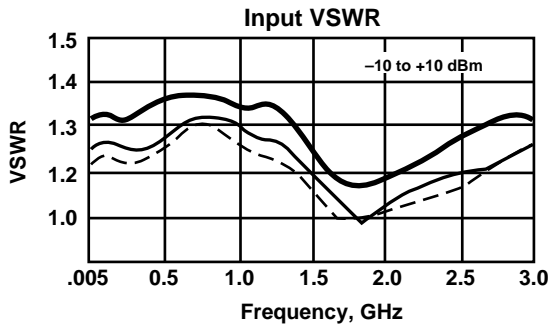
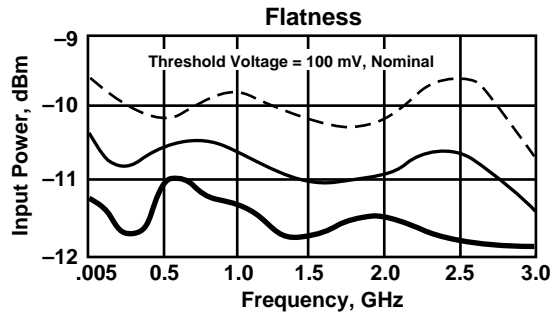
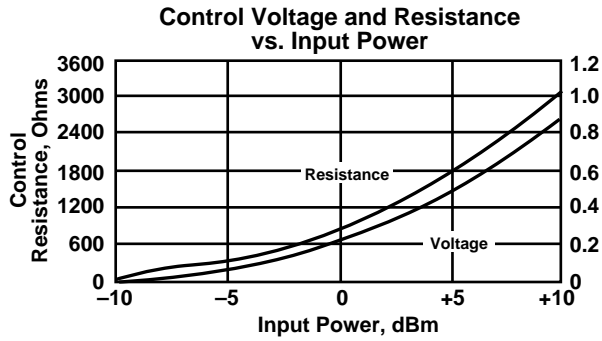

Product Options

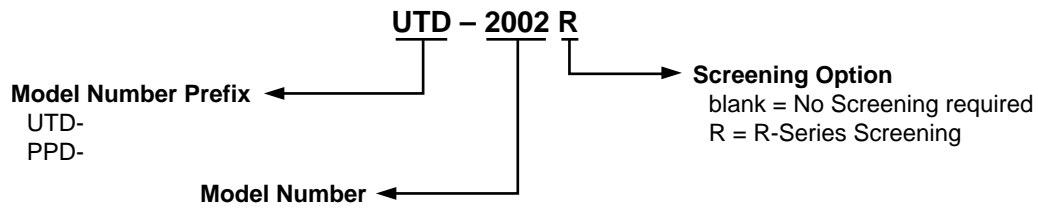

Contact your nearest HP sales office and/or distributor for assistance in ordering this product.

Case Drawings TO-8F

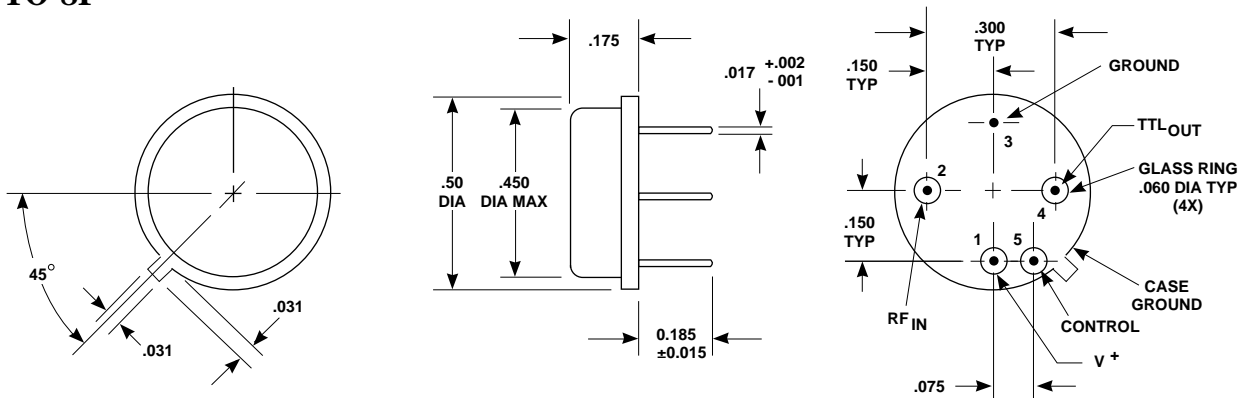

APPROXIMATE WEIGHT 2.1 GRAMS

NOTES (UNLESS OTHERWISE SPECIFIED):
 1. DIMENSIONS ARE SPECIFIED IN INCHES
 2. TOLERANCES: xx ± .02
 xxx ± .010

Contact Teledyne Microwave Solutions:
 650-691-9800
 650-962-6845 fax

Check for updates:
www.teledynemicrowave.com