

Analog Level Detectors

10 to 1000 MHz

Technical Data

UTD-1000/1001

Features

- -120 mV Output for -10 dBm Pin
- ±1.0 dB Flatness
- 50- or 300-Ohm Impedance

Applications

- Specifically Designed for System Built-in Test
- RF/IF Monitor
- Level Control
- UTD-1001 Can Be Used Without a Coupler in Many Cases

Description

The UTD-1000 has an input impedance of 50 ohms. The UTD-1001 has an input impedance of greater than 300 ohms. In all other respects the detectors are similar. The level detector consists of an amplifier stage that drives a Schottky-barrier detector diode. Matched back-to-back silicon diodes which are closely thermally-coupled to the detector provide a DC tracking reference.

Pin Configuration TO-8F

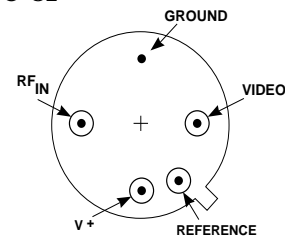

Schematic

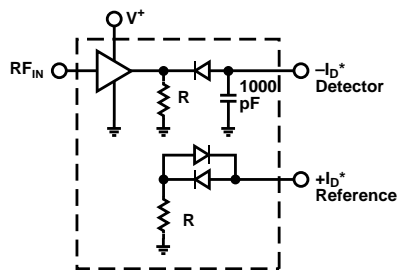

* Requires external bias resistors see "Application Note", Section 7.

Maximum Ratings

Parameter	Maximum
Bias Current (diode)	1 mA
Continuous RF Input Power	+17.0 dBm
Operating Case Temperature	-54°C to +125°C
Storage Temperature	-62°C to +150°C
"R" Series Burn-In Temperature	+125°C
Pulse Input Power (1.0 minute max.)	100 mW
Junction Temperature Above Case Temperature	3°C

Weight: (typical) 2.1 grams

Electrical Specifications

(Measured in 50 Ω system @ +15 VDC nominal)

Symbol	Characteristic	Typical $T_C = 25^\circ\text{C}$	Guaranteed Specifications		Unit
			$T_C = 0$ to 50°C	$T_C = -55$ to $+85^\circ\text{C}$	
—	Detected Voltage (Min.) $f = 500$ MHz, cond. ^{1,2}	-120	-90	—	mV
—	Flatness (referred to input) (Max.) $f = 10$ -1000 MHz, cond. ^{1,2}	± 0.7	± 1.0	—	dB
—	Variation Over Temperature (referred to input), $f = 500$ MHz, cond. ^{1,2,3}	± 1.0	—	—	dB
—	Input VSWR, 50 Ω (UTD-1000 only) (Max.) $f = 10$ -500 MHz	1.5:1	1.7:1	—	—
—	Input Impedance (UTD-1001 only) Equivalent resistance Equivalent capacitance	300 Ω 3.3 pf	— —	— —	— —
—	Input 3rd Order Intercept Point $f = 10$ -500 MHz	+20	—	—	dBm
—	Output Offset Voltage (Max.) $I_D = I_{REF} = 50$ μA , no RF drive	± 10.0	± 15.0	—	mV
—	Differential Voltage Tracking	± 5.0	—	—	mV
—	Output Capacitance	1000	1300	—	pf

- Conditions:
- $I_D = 50$ μA , $R = 10\text{K}$ Ω
 - $P_{IN} = -10$ dBm (RF input)
 - Typical variation over -55° to $+85^\circ\text{C}$

Product Options

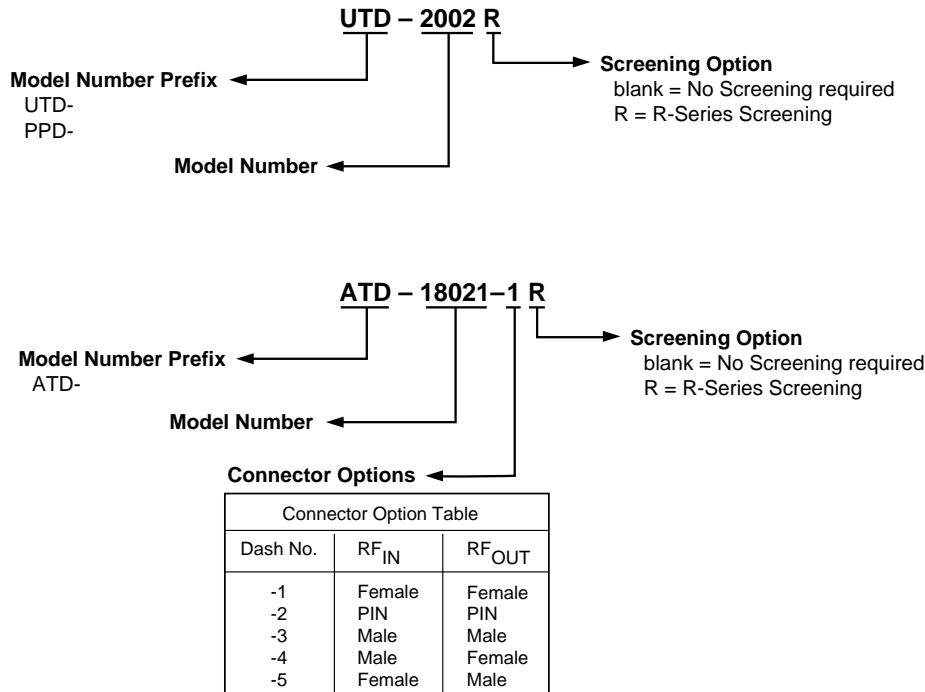

Typical Performance @ 25°C

Key: +25°C ———
 +85°C - - - -
 -55°C = = = =

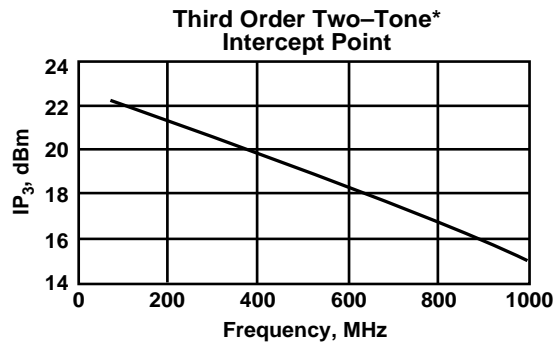
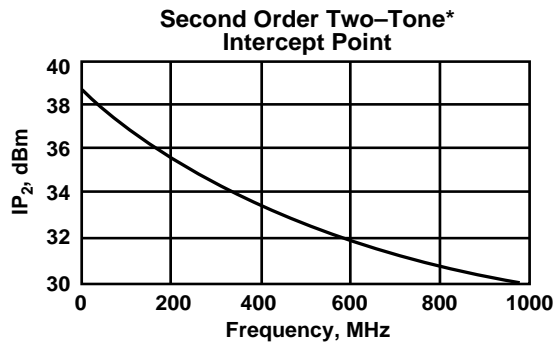
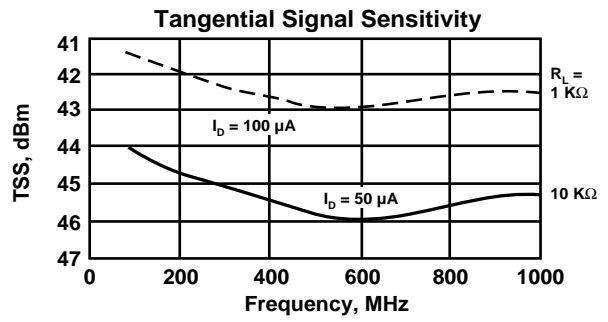
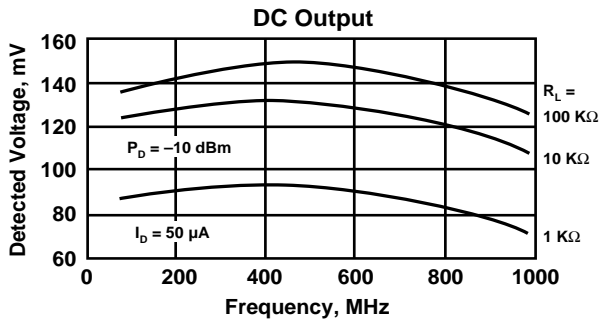
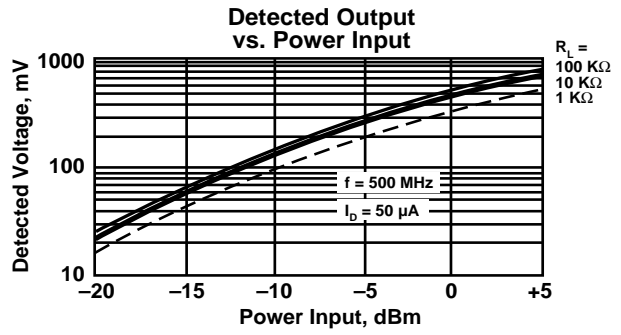
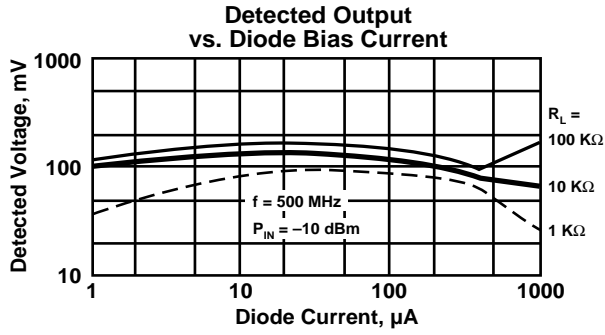

* Distortion Curves relative to the UTD-1001 operated in shunt with a 50Ω RF line.
 (See "Application Note" in Section 7.)

**Case Drawings
TO-8F**

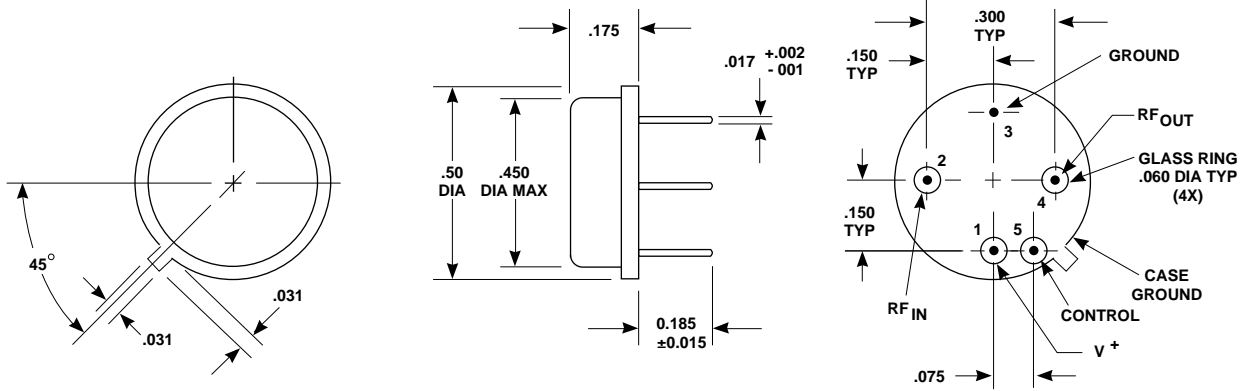

APPROXIMATE WEIGHT 2.1 GRAMS

- NOTES (UNLESS OTHERWISE SPECIFIED):**
1. DIMENSIONS ARE SPECIFIED IN INCHES
 2. TOLERANCES: xx ± .02
xxx ± .010

Contact Teledyne Microwave Solutions:
650-691-9800
650-962-6845 fax

Check for updates:
www.teledynemicrowave.com