



# Voltage-Controlled Signal Limiter 5 to 1000 MHz

## Technical Data

**UTL-1001/1002**

### Features

- 0 to -13 dBm Programmable Output
- VSWR less than 2.0:1

### Applications

- Protection for Detectors, Mixers, and Amplifiers
- Cascadable Gain Control
- EW Receiver Circuits
- Wideband System Protection

### Description

The UTL Series consists of two voltage controlled signal limiters which cover the 5 to 1000 MHz frequency range. These thin-film limiters feature voltage programmable output levels with input levels as high as +26 dBm. They have low VSWR, low insertion loss, and excellent second- and third-harmonic suppression. Recovery from fully saturated input levels is less than 50 nano-seconds. The UTL models are provided in the TO-8 package.

### Pin Configuration TO-8U

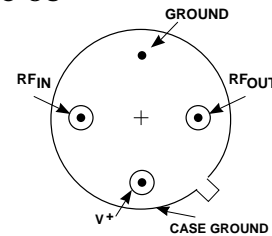

### Schematic

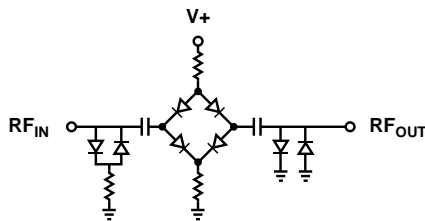

### Maximum Ratings

Parameter	Maximum
DC Voltage	+25.0 V
Continuous RF Input Power	+26.0 dBm
Peak Input Power (3 μsec Max.)	+30 dBm
Operating Case Temperature	-54°C to +125°C
Storage Temperature	-62°C to +150°C
"R" Series Burn-In Temperature	+125°C

**Weight:** (typical) 2.1 grams

## Electrical Specifications

(Measured in 50  $\Omega$  system @ +15 VDC nominal unless otherwise noted)

Symbol	Characteristic	Typical $T_c = 25^\circ\text{C}$	Guaranteed Specifications	Unit
			$T_c = 0 \text{ to } 50^\circ\text{C}$	
BW	Frequency Range			
	UTL-1001	50-1000	50-1000	MHz
	UTL-1002	5-1000	5-1000	MHz
—	Output Level at Limiting Threshold (1 dB Compression) (Max)			
	+20 volts bias	0	+2	dBm
	+15 volts bias	-2	0	dBm
	+10 volts bias	-6	-4	dBm
	+5 volts bias	-13	—	dBm
—	Maximum Output Limiting Level (+20 dBm Input)			
	+20 volts bias	0	+2	dBm
	+15 volts bias	-1	+1	dBm
	+10 volts bias	-4	-2	dBm
	+5 volts bias	-9	—	dBm
—	Maximum Insertion Loss at 500 MHz @ -20 dBm input			
	+20 volts bias	1.6	2.0	dB
	+15 volts bias	1.9	2.4	dB
	+10 volts bias	2.5	3.0	dB
	+5 volts bias	4.3	—	dB
—	Maximum Insertion Loss at 1000 MHz			
	+20 volts bias	2.0	2.5	dB
	+15 volts bias	2.5	3.0	dB
	+10 volts bias	3.1	3.7	dB
	+5 volts bias	5.2	—	dB
—	Input VSWR, $P_{IN} < +20 \text{ dBm}$	—	2.0:1	—
—	Output VSWR, $P_{IN} < -10 \text{ dBm}$	—	2.0:1	—
—	Output Level Variation vs. Temperature	—	$\pm 1.0$	dB
—	Bias Current			
	At +20 VDC	10	—	mA
	At +15 VDC	7	—	mA

**Typical Performance At 25°C Temperature** (at +15 VDC unless otherwise noted)

Bias Voltage: 5V ———  
 10V - - - -  
 15V - · - · -  
 20V ———

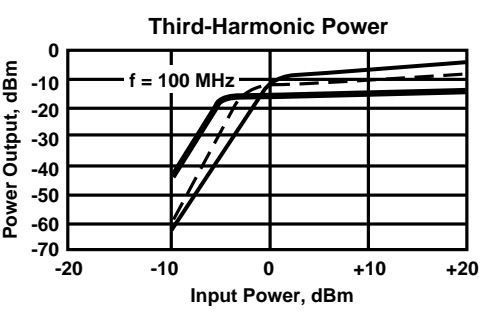
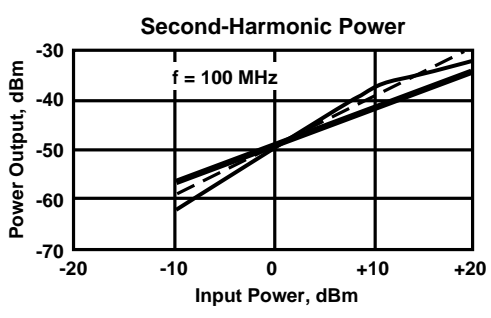
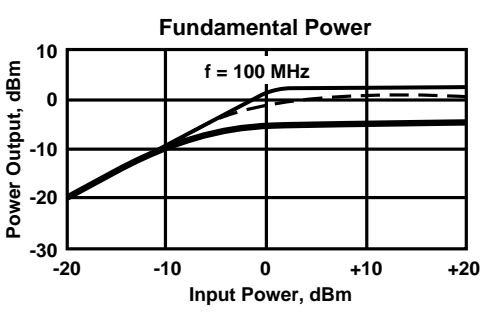
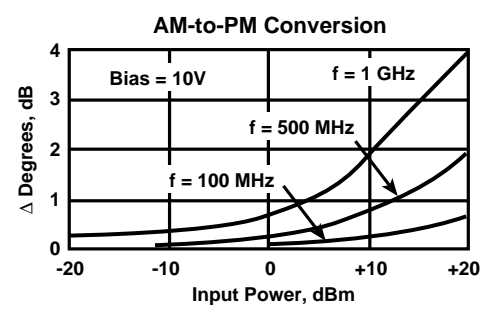
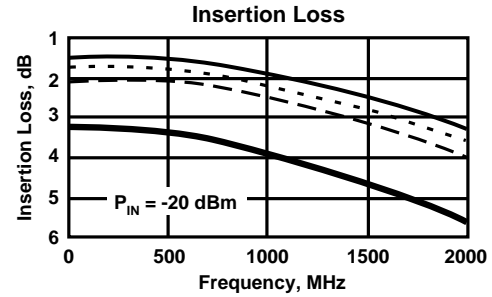
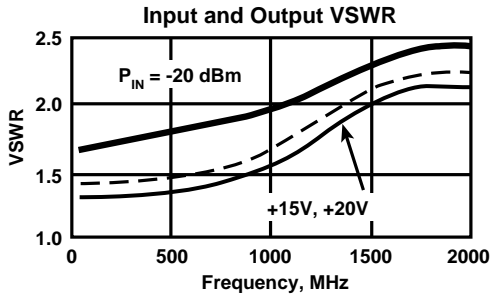

## Typical Performance At 25°C Temperature (at +15 VDC unless otherwise noted)

Bias Voltage: 5V ———  
 10V - - - -  
 15V - - - -  
 20V ———

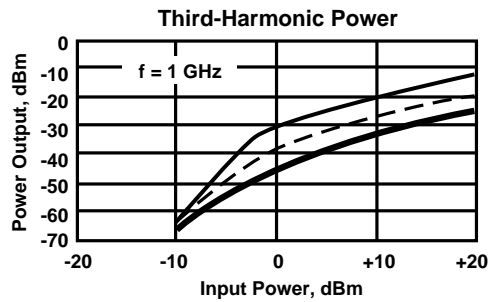
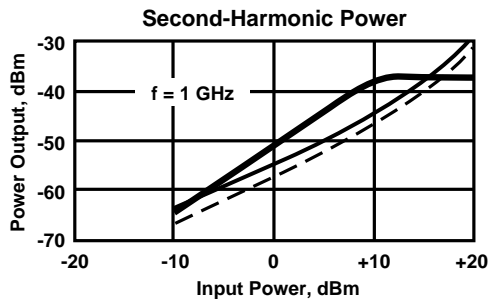
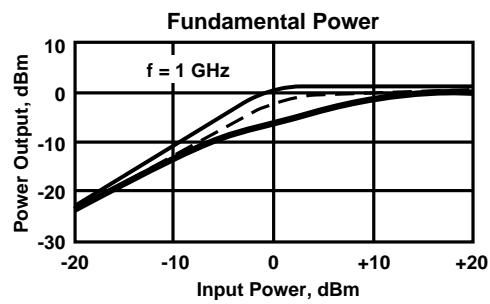
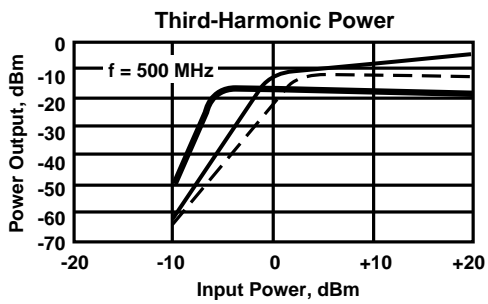
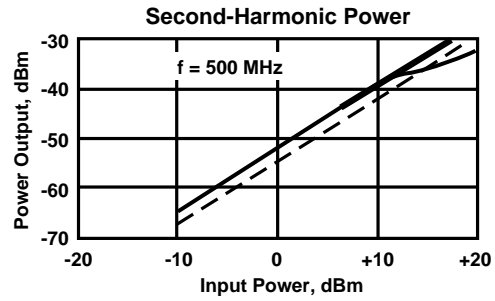
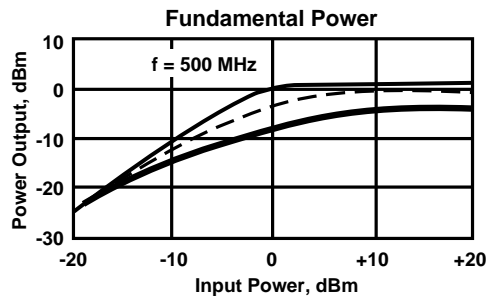

### Product Options

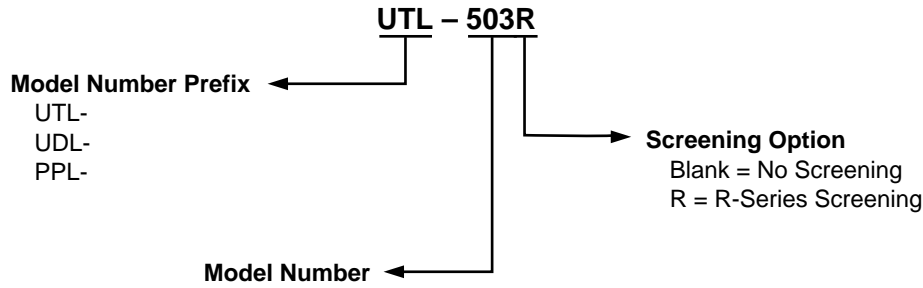

### Case Drawings TO-8U

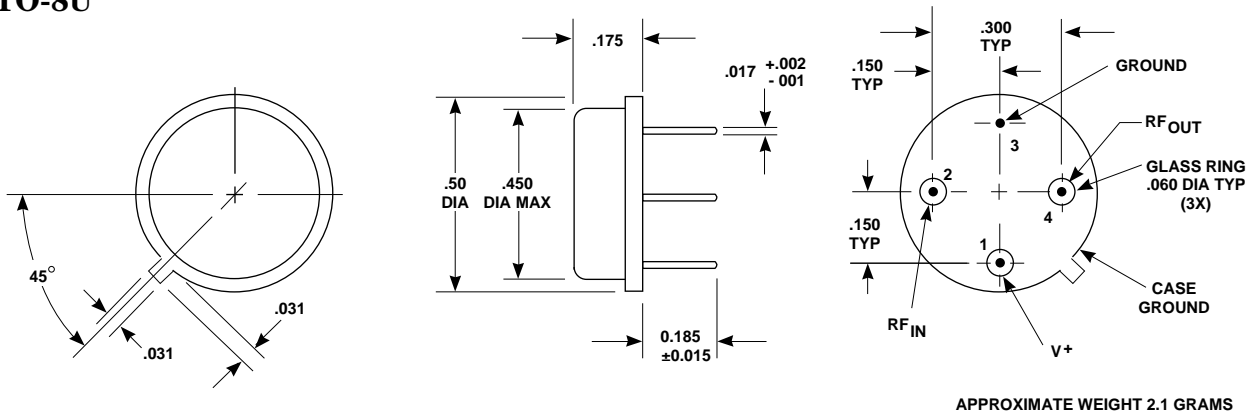

**NOTES (UNLESS OTHERWISE SPECIFIED):**  
 1. DIMENSIONS ARE SPECIFIED IN INCHES  
 2. TOLERANCES:   xx ± .02  
                       xxx ± .010

Contact Teledyne Microwave Solutions:  
 650-691-9800  
 650-962-6845 fax

Check for updates:  
[www.teledynemicrowave.com](http://www.teledynemicrowave.com)