



Thin-Film Cascadable Amplifier 5 to 1000 MHz

Technical Data

UTM-1053

Features

- **Frequency Range: 5 to 1000 MHz**
- **MODAMP Silicon Monolithic Gain Stages**
- **High Gain: +30 dB (Typ)**
- **Low VSWR**

Applications

- **IF/RF Amplification**

Description

The UTM-1053 contains three silicon monolithic microwave integrated circuit RF amplifiers mounted on a thin-film substrate to provide wideband, high gain performance. Internal blocking capacitors couple the RF through this three-stage amplifier. The UTM-1053 is available in the TO-8 hermetic package.

Pin Configuration

UTM—TO-8U

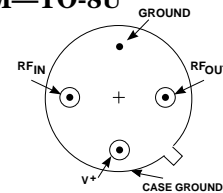

Schematic

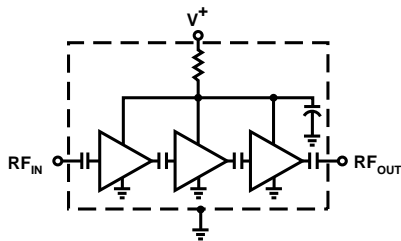

Maximum Ratings

Parameter	Maximum
DC Voltage	+17 Volts
Continuous RF Input Power	+17 dBm
Operating Case Temperature	-55 to +125°C
Storage Temperature	-62 to +150°C
"R" Series Burn-In Temperature	+125°C

Thermal Characteristics¹

θ_{JC}	130/130/130°C/W ²
Active Transistor Power Dissipation	125/125/175 mW ²
Junction Temperature Above Case Temperature	16/16/23°C ²
MTBF (MIL-HDBK-217E, A_{UF} @ 90°C)	535,000 Hrs.

Notes:

1. Values refer to 1st, 2nd, 3rd stage transistors respectively.

Weight: (typical) UTM—2.1 grams

Electrical Specifications

(Measured in 50 Ω system @ +15 VDC nominal unless otherwise noted)

Symbol	Characteristic	Typical $T_C = 25^\circ\text{C}$	Guaranteed Specifications		Unit
			$T_C = 0 \text{ to } 50^\circ\text{C}$	$T_C = -55 \text{ to } +85^\circ\text{C}$	
BW	Frequency Range	5-1000	5-1000	5-1000	MHz
GP	Small Signal Gain (Min.)	30.0	27.0	25.0	dB
—	Gain Flatness (Max.)	± 1.5	± 2.0	± 2.0	dB
NF	Noise Figure (Max.)	8.0	9.0	9.0	dB
P _{1dB}	Power Output @ +1 dB Comp. (Min.)	+9.0	+5.0	+4.0	dBm
—	Input VSWR (Max.)	1.5:1	2.0:1	2.0:1	—
—	Output VSWR (Max.)	1.5:1	2.0:1	2.0:1	—
IP ₃	Two Tone 3rd Order Intercept Point	+21.0	—	—	dBm
IP ₂	Two Tone 2nd Order Intercept Point	+30.0	—	—	dBm
HP ₂	One Tone 2nd Harmonic Intercept Point	+35.0	—	—	dBm
I _D	DC Current	90	—	—	mA

Typical Performance Over Temperature (@ +15 VDC unless otherwise noted)

Key: +25°C —
+85°C - -
-55°C —

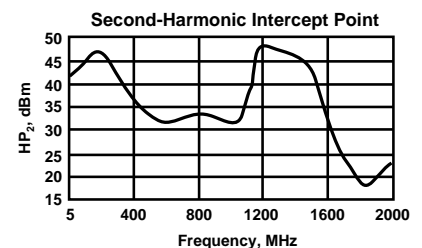
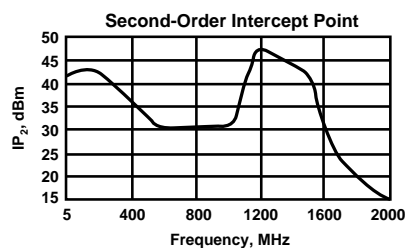
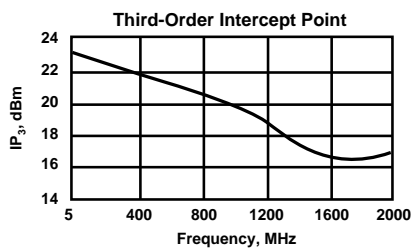
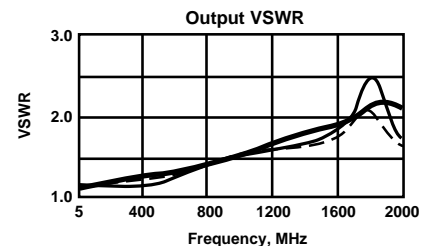
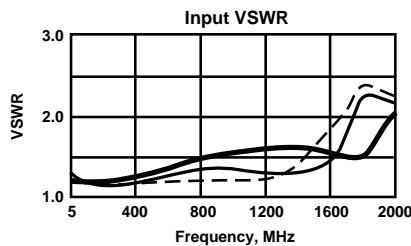
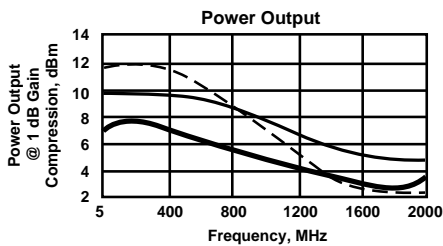
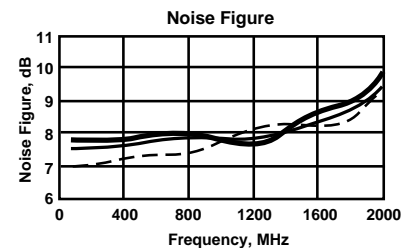
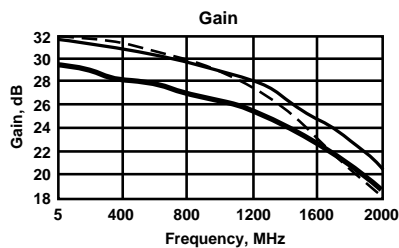

Automatic Network Analyzer Measurements (Typical production unit @ +25°C ambient)**Numerical Readings****Bias = 15.00 Volts**

FREQUENCY MHz	VSWR IN	GAIN dB	PHASE DEV	GROUP DELAY ns	VSWR OUT	ISOLATION dB
100.0	1.15	31.10	2.01	.00	1.06	43.20
200.0	1.08	30.79	.12	.74	1.13	48.73
300.0	1.12	30.46	-.76	.67	1.15	58.84
400.0	1.16	30.11	-.94	.68	1.20	55.41
500.0	1.22	29.90	-.96	.66	1.24	51.72
600.0	1.27	29.77	-.07	.65	1.30	54.65
700.0	1.31	29.48	.17	.67	1.33	49.54
800.0	1.36	29.20	.60	.68	1.39	51.27
900.0	1.39	28.99	.34	.69	1.43	49.36
1000.0	1.41	28.85	-.55	.70	1.49	47.69

S-Parameters**Bias = 15.00 Volts**

FREQUENCY MHz	S ₁₁		S ₂₁		S ₁₂		S ₂₂	
	Mag	Ang	dB	Ang	dB	Ang	Mag	Ang
100.00	.055	-166.8	31.488	159.6	-49.622	23.4	.041	-18.5
150.00	.044	-162.6	31.381	148.6	-52.352	8.1	.048	-16.8
200.00	.044	-151.7	31.268	137.8	-54.150	39.4	.058	-24.8
250.00	.049	-139.7	31.171	128.3	-55.565	80.8	.064	-33.3
300.00	.051	-127.9	31.000	118.6	-59.922	73.1	.067	-39.4
350.00	.059	-118.6	30.855	109.3	-52.893	30.4	.080	-45.1
400.00	.069	-115.4	30.656	100.1	-58.065	91.3	.088	-50.9
450.00	.080	-109.4	30.510	90.7	-56.606	54.3	.098	-55.2
500.00	.090	-109.4	30.398	81.6	-59.501	70.4	.110	-60.7
550.00	.101	-108.8	30.297	72.5	-60.129	47.5	.121	-64.0
600.00	.113	-110.1	30.230	63.6	-55.868	61.5	.133	-67.3
650.00	.123	-110.7	30.113	54.6	-53.130	96.5	.144	-69.9
700.00	.132	-112.5	29.959	45.6	-55.095	70.4	.152	-73.8
750.00	.140	-115.8	29.853	36.4	-54.666	85.4	.164	-77.6
800.00	.149	-119.4	29.662	26.8	-51.949	80.2	.176	-78.5
850.00	.155	-122.0	29.525	16.8	-53.425	106.0	.181	-79.9
900.00	.159	-124.5	29.375	6.9	-51.872	93.9	.186	-82.6
950.00	.166	-128.1	29.324	-3.2	-50.651	113.6	.198	-84.3
1000.00	.169	-130.1	29.172	-13.0	-51.330	100.3	.206	-84.9
1100.00	.167	-132.8	28.807	-32.5	-49.174	118.9	.216	-88.3
1200.00	.163	-132.6	28.347	-52.9	-46.878	123.1	.233	-89.2
1300.00	.156	-129.7	27.681	-72.8	-46.023	116.7	.242	-91.5
1400.00	.157	-123.8	26.792	-92.0	-44.046	115.0	.259	-92.8
1500.00	.171	-117.3	25.869	-109.8	-42.855	112.2	.270	-94.0
1600.00	.204	-112.8	24.811	-126.6	-40.686	112.2	.301	-97.7
1700.00	.222	-109.9	23.520	-142.2	-38.903	108.0	.292	-100.5
1800.00	.389	-95.2	23.283	-154.1	-35.449	53.8	.427	-93.3
1900.00	.394	-126.1	21.584	-175.4	-44.824	72.7	.352	-120.1
2000.00	.363	-137.2	20.254	172.3	-41.273	95.2	.280	-123.3

Product Options

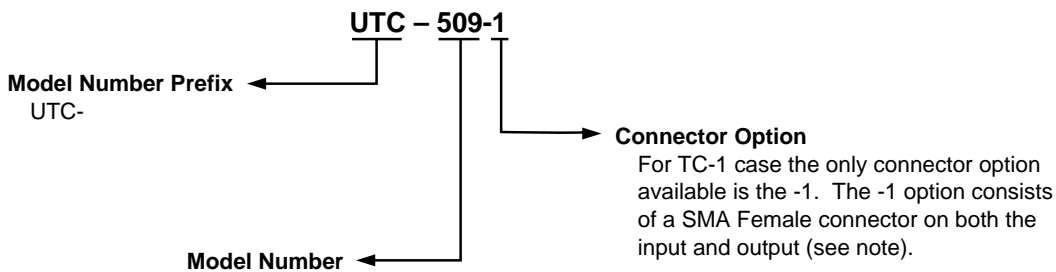
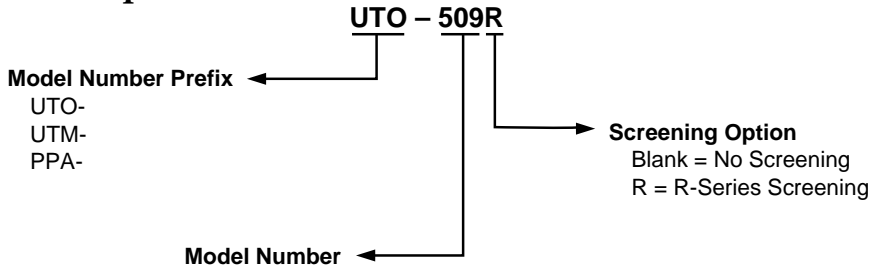

Note: R-Series screening is not available in the TC-1 case as the case is non-hermetic.

Case Drawings TO-8U

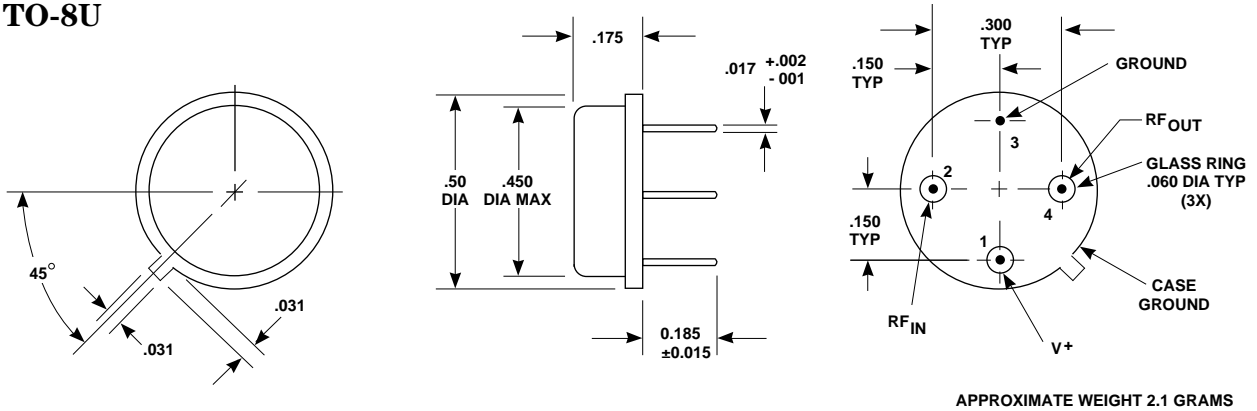

- NOTES (UNLESS OTHERWISE SPECIFIED):
1. DIMENSIONS ARE SPECIFIED IN INCHES
 2. TOLERANCES: xx ± .02
xxx ± .010

Contact Teledyne Microwave Solutions:
 650-691-9800
 650-962-6845 fax

Check for updates:
www.teledynemicrowave.com