



Thin-Film Cascadable Amplifier 10 to 200 MHz

Technical Data

UTO/UTC 210 Series

Features

- **Frequency Range: 10 to 200 MHz**
- **Ultra Low Noise: 1.5 dB (Typ)**
- **Low Current Drain: 15 mA (Typ)**
- **Temperature Compensated**
- **Surface Mount Option**
- **High Efficiency**

Applications

- **RF Front Ends**
- **IF Medical Systems**
- **Surface Mount Assembly**

Description

The 210 Series is a thin-film bipolar, medium-gain, low-noise, RF amplifier suitable for front end design. It utilizes lossless feedback circuitry for low power consumption and high dynamic range. Resistive feedback and active bias provide temperature compensation and increased immunity to bias voltage variations. The 210 Series amplifiers are available in three packages: the surface mount PlanarPak PP-38 (.375 in. x .375 in.) case, the TO-8 hermetic case and the connectorized TC-1A case.

Pin Configuration

UTO—TO-8T

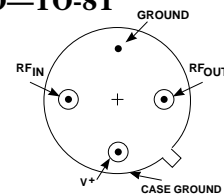

UTC—TC-1A

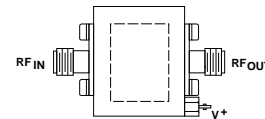

Schematic

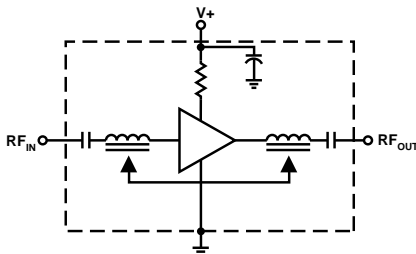

Maximum Ratings

Parameter	Maximum
DC Voltage	17 Volts
Continuous RF Input Power	+13 dBm
Operating Case Temperature	-55 to +125°C
Storage Temperature	-62 to +150°C
“R” Series Burn-In Temperature	+125°C

Thermal Characteristics¹

θ_{JC}	120°C/W
Active Transistor Power Dissipation	77 mW
Junction Temperature Above Case Temperature	9°C
MTBF (MIL-HDBK-217E, A_{UF} @ 90°C)	1,375,000 Hrs.

Weight: (typical) PPA—0.5 grams; UTO—2.1 grams; UTC—21.5 grams

Electrical Specifications

(Measured in 50 Ω system @ +15 VDC nominal unless otherwise noted)

Symbol	Characteristic	Typical $T_C = 25^\circ\text{C}$	Guaranteed Specifications		Unit
			$T_C = 0 \text{ to } 50^\circ\text{C}$	$T_C = -55 \text{ to } +85^\circ\text{C}$	
BW	Frequency Range	10-200	10-200	10-200	MHz
GP	Small Signal Gain (Min.)	9.0	8.0	7.5	dB
—	Gain Flatness (Max.)	± 0.5	± 1.0	± 1.0	dB
NF	Noise Figure (Max.)	1.5	2.0	2.5	dB
P _{1dB}	Power Output @ +1 dB Comp. (Min.)	+13	+11.0	+11.0	dBm
—	Input VSWR (Max.)	<1.5:1	2.0:1	2.0:1	—
—	Output VSWR (Max.)	<1.5:1	2.0:1	2.0:1	—
IP ₃	Two Tone 3rd Order Intercept Point	+29.0	—	—	dBm
IP ₂	Two Tone 2nd Order Intercept Point	+40.0	—	—	dBm
HP ₂	One Tone 2nd Harmonic Intercept Point	+45.0	—	—	dBm
I _D	DC Current	15	—	—	mA

Typical Performance Over Temperature (@ +15 VDC unless otherwise noted)

Key: +25°C —
+85°C —
-55°C —

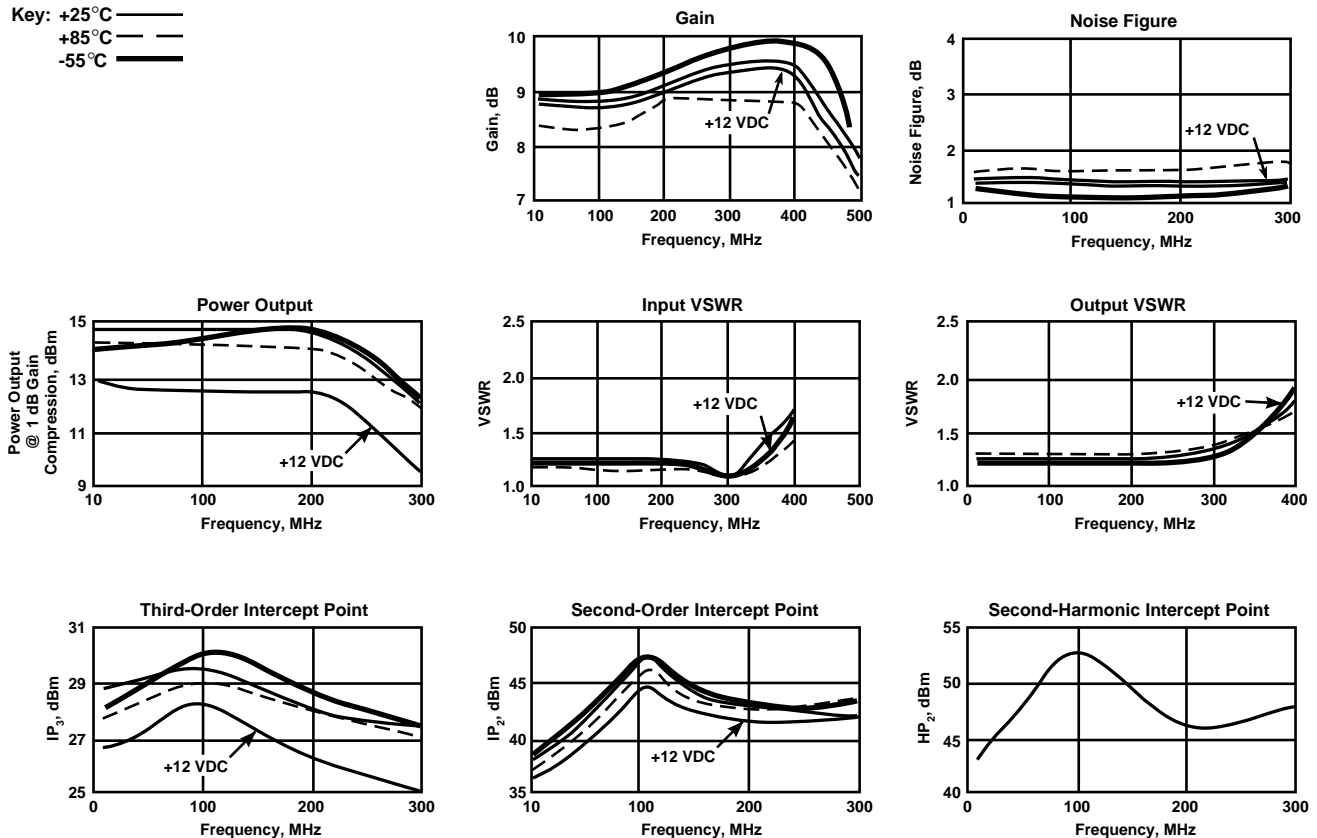

Automatic Network Analyzer Measurements (Typical production unit @ +25°C ambient)

Numerical Readings
Bias = 15.00 Volts

FREQUENCY MHz	VSWR IN	GAIN dB	PHASE DEGREES	PHASE DEV	GROUP DELAY ns	VSWR OUT	ISOLATION dB
100.0	1.17	8.80	-18.96	-1.14	.00	1.16	11.24
120.0	1.19	5.55	-22.60	-.53	.53	1.17	11.44
140.0	1.21	8.89	-26.53	-.22	.55	1.17	11.43
160.0	1.22	8.94	-30.50	.04	.50	1.18	11.55
150.0	1.23	9.00	-33.77	1.02	.52	1.18	11.64
200.0	1.22	5.05	-37.96	1.09	.60	1.18	11.81
220.0	1.21	9.15	-42.38	.91	.61	1.17	11.90
240.0	1.18	9.22	-46.70	.83	.63	1.17	12.11
260.0	1.14	9.29	-51.51	.26	.69	1.17	12.28
250.0	1.09	9.39	-56.55	-.57	.73	1.18	12.49
300.0	1.04	9.46	-61.96	-1.70	.81	1.21	12.73
400.0	1.62	9.55	-94.33		.99	1.77	14.61
500.0	3.60	7.93	-131.04		.95	3.41	18.63
600.0	7.61	4.61	-155.21		.66	5.54	24.82
700.0	13.19	.90	-179.04		.47	7.55	29.91
800.0	18.54	-2.13	165.55		.36	9.00	30.40
900.0	24.65	-4.88	153.02		.34	9.29	27.45
1000.0	27.56	-7.37	143.66		.00	9.25	24.15

LINEARIZATION RANGE: 100.0 to 200.0 MHz

S-Parameters
Bias = 15.00 Volts

FREQUENCY MHz	S ₁₁		S ₂₁		S ₁₂		S ₂₂	
	Mag	Ang	dB	Ang	dB	Ang	Mag	Ang
100.00	.077	38.4	8.779	-18.9	-11.284	-17.0	.075	128.5
120.00	.057	36.8	8.852	-22.7	-11.336	-21.1	.077	120.9
140.00	.056	36.6	8.890	-26.6	-11.389	-24.5	.050	114.7
160.00	.100	34.5	8.948	-30.5	-11.544	-28.3	.053	111.4
180.00	.102	31.1	9.015	-34.0	-11.665	-31.7	.054	108.1
200.00	.100	27.7	9.053	-38.2	-11.779	-35.5	.053	105.6
220.00	.054	22.1	9.153	-42.4	-11.942	-39.2	.053	106.7
240.00	.053	16.3	5.233	-46.9	-12.118	-43.3	.051	110.4
260.00	.066	8.2	9.300	-51.6	-12.318	-47.9	.055	117.0
250.00	.046	-2.2	5.355	-56.7	-12.449	-52.4	.091	125.9
300.00	.019	-24.4	9.472	-52.1	-12.751	-56.5	.102	133.6
400.00	.237	152.1	5.566	-54.5	-14.552	-85.2	.282	139.5
500.00	.564	112.2	7.924	-131.1	-18.699	-115.4	.548	110.4
600.00	.769	79.1	4.605	-159.0	-24.510	-140.5	.706	79.6
700.00	.560	56.1	.914	-179.1	-29.931	-161.1	.774	56.3
500.00	.904	39.1	-2.125	165.5	-30.400	172.9	.797	38.7
900.00	.924	25.5	-4.839	153.3	-27.455	154.0	.806	25.3
1000.00	.930	12.4	-7.371	143.6	-24.167	139.2	.805	13.2

Product Options

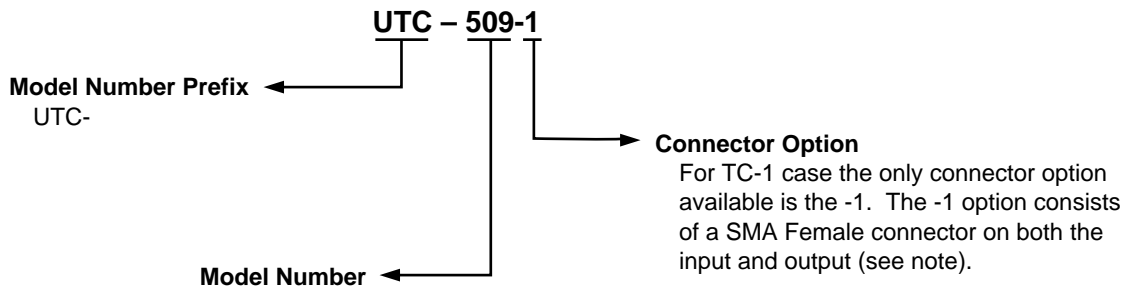
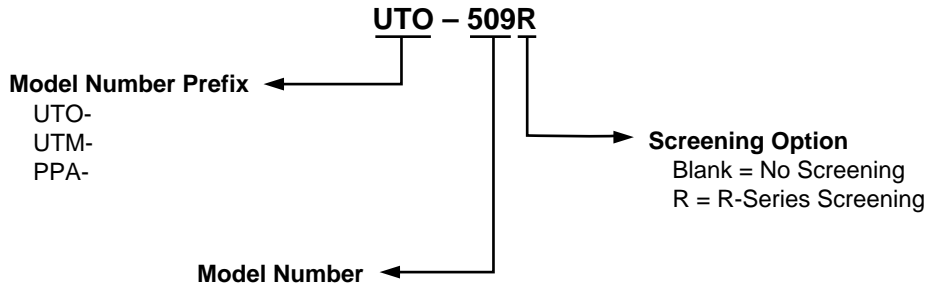

Note: R-Series screening is not available in the TC-1 case as the case is non-hermetic.

Case Drawings TO-8T

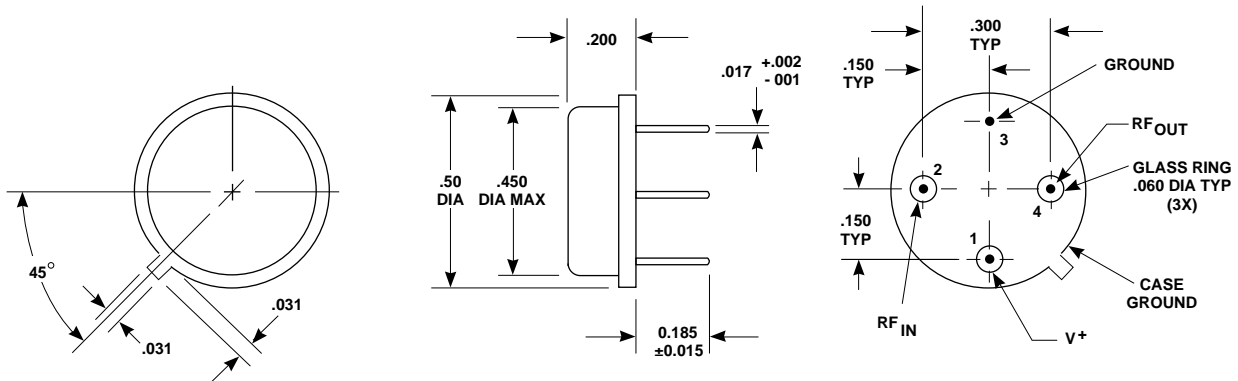

APPROXIMATE WEIGHT 2.1 GRAMS

- NOTES (UNLESS OTHERWISE SPECIFIED):**
 1. DIMENSIONS ARE SPECIFIED IN INCHES
 2. TOLERANCES: xx ± .02
 xxx ± .010

TC-1A

