



Thin-Film Cascadable Amplifier

20 to 400 MHz

Technical Data

UTO/UTC 441 Series

Features

- **Frequency Range: 20 to 400 MHz**
- **Low Current Drain: 32 mA (Typ)**
- **Medium Output Power: +16 dBm (Typ)**
- **High Dynamic Range: 85 dB (Typ)¹**
- **Three Package Options**
- **Temperature Compensated**

Applications

- **Medium Gain RF/IF Signal Processing**
- **Surface Mount Assembly**

Description

The 441 Series RF amplifiers are medium gain, bipolar components built on a thin-film substrate, using output transformer coupling to increase efficiency. Internal blocking capacitors couple the RF signal through the amplifier. The 441 Series amplifiers are available in three packages: the hermetic surface mount PP-38 case (.375 x .375 in.), the connectorized TC-1A case, and the hermetic TO-8T case.

Pin Configuration

UTO—TO-8T

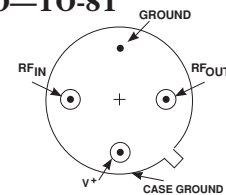

UTC—TC-1A

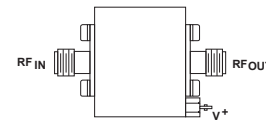

Schematic

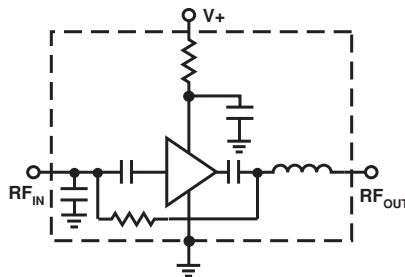

Maximum Ratings

Parameter	Maximum
DC Voltage	+17 Volts
Continuous RF Input Power	+13 dBm
Operating Case Temperature	-55 to +125°C
Storage Temperature	-62 to +150°C
“R” Series Burn-In Temperature	+125°C

Thermal Characteristics¹

θ_{JC}	105°C/W
Active Transistor Power Dissipation	275 mW
Junction Temperature Above Case Temperature	29°C
MTBF (MIL-HDBK-217E, A_{UF} @ 90°C)	523,897 Hrs.

Weight: (typical) UTO—2.1 grams; UTC—21.5 grams

Electrical Specifications¹

(Measured in 50 Ω system @ +15 VDC nominal unless otherwise noted)

Symbol	Characteristic	Typical $T_C = 25^\circ\text{C}$	Guaranteed Specifications		Unit
			$T_C = 0 \text{ to } 50^\circ\text{C}$	$T_C = -55 \text{ to } +85^\circ\text{C}$	
BW	Frequency Range	20-400	20-400	20-400	MHz
GP	Small Signal Gain (Min.)	14.4	13.5	13.0	dB
—	Gain Flatness (Max.)	± 0.1	± 0.7	± 0.7	dB
NF	Noise Figure (Max.)	3.7	4.5	5.0	dB
P _{1dB}	Power Output @ +1 dB Comp. (Min.)	+16.0	+15.0	+15.0	dBm
—	Input VSWR (Max.)	1.3:1	2.0:1	2.0:1	—
—	Output VSWR (Max.)	1.6:1	2.0:1	2.0:1	—
IP ₃	Two Tone 3rd Order Intercept Point	+32.0	—	—	dBm
IP ₂	Two Tone 2nd Order Intercept Point	+44.0	—	—	dBm
HP ₂	One Tone 2nd Harmonic Intercept Point	+53.0	—	—	dBm
I _D	DC Current	32	—	—	mA

Notes: 1: Calculated spurious free dynamic range in 1 MHz bandwidth.

2: A portion of any DC voltage applied to the RF input pin will appear at the RF output pin (i.e., a resistive DC path exists between pins.) There is no input or output blocking capacitor.

Typical Performance Over Temperature (@ +15 VDC unless otherwise noted)

Key: +25°C ———
+85°C - - - -
-55°C ———

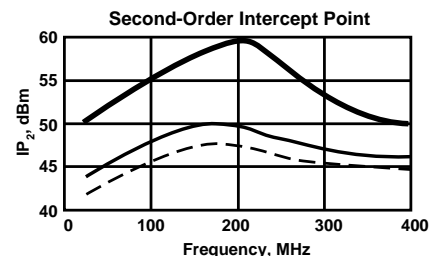
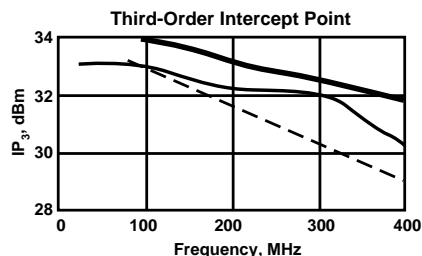
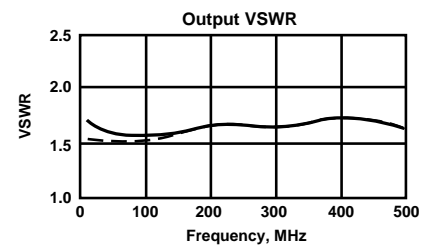
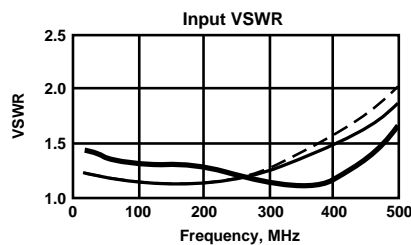
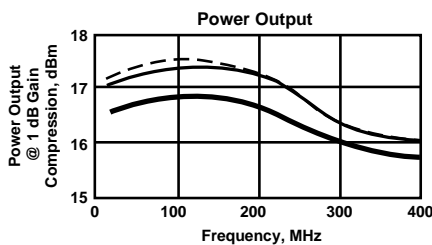
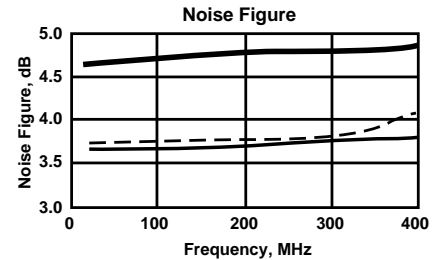
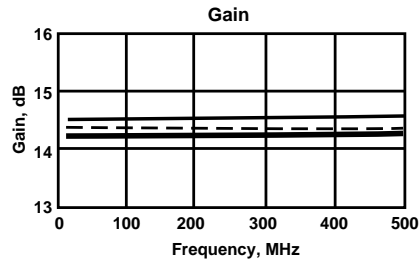

Automatic Network Analyzer Measurements (Typical production unit @ +25°C ambient)

Numerical Readings
Bias = 15.00 Volts

FREQUENCY MHz	VSWR IN	GAIN dB	PHASE DEGREES	PHASE DEV	GROUP DELAY ns	VSWR OUT	ISOLATION dB
100.0	1.29	14.47	159.85	-.20	.00	1.58	20.57
200.0	1.16	14.48	137.59	-.04	.61	1.60	20.54
300.0	1.10	14.47	115.94	.71	.63	1.62	20.67
400.0	1.31	14.55	92.37	-.46	.66	1.61	20.80
500.0	1.65	14.55	68.22		.71	1.58	20.75
600.0	2.06	14.02	40.97		.81	1.62	20.80
700.0	2.42	12.99	9.62		.86	2.05	21.14
800.0	2.57	11.24	-20.83		.81	2.97	21.80
900.0	2.62	8.62	-48.65		.69	4.23	22.93
1000.0	2.85	5.58	-70.55		.56	5.82	24.28
1100.0	3.22	2.48	-88.84		.48	7.37	25.47
1200.0	3.73	-.38	-105.01		.39	8.14	26.46
1300.0	4.35	-3.09	-116.83		.30	8.94	27.45
1400.0	4.91	-5.58	-126.82		.31	10.05	28.28
1500.0	5.33	-7.73	-138.87		.29	11.49	28.62
1600.0	5.80	-9.13	-147.96		.26	11.93	29.21
1700.0	6.49	-10.02	-157.56		.33	14.13	29.82
1800.0	7.49	-10.22	-171.66		.43	15.96	31.03
1900.0	8.86	-10.72	171.53		.52	17.35	32.54
2000.0	10.69	-11.10	151.12		.00	19.05	32.88

LINEARIZATION RANGE: 100.0 to 400.0 MHz

S-Parameters
Bias = 15.00 Volts

FREQUENCY MHz	S ₁₁		S ₂₁		S ₁₂		S ₂₂	
	Mag	Ang	dB	Ang	dB	Ang	Mag	Ang
100.00	.125	175.3	14.498	159.7	-20.566	-9.0	.226	175.3
200.00	.067	173.3	14.473	137.4	-20.541	-20.6	.231	170.6
300.00	.044	-98.1	14.512	115.4	-20.672	-29.1	.235	159.9
400.00	.140	-79.8	14.572	92.0	-20.798	-40.4	.230	141.4
500.00	.251	-90.2	14.575	67.6	-20.749	-51.7	.215	108.7
600.00	.349	-102.5	14.047	40.0	-20.802	-63.7	.233	56.4
700.00	.408	-116.5	12.979	8.1	-21.145	-77.8	.336	-.4
800.00	.430	-125.3	11.186	-22.4	-21.804	-93.2	.493	-41.5
900.00	.441	-129.2	8.527	-50.5	-22.933	-107.6	.625	-71.5
1000.00	.476	-130.9	5.423	-71.7	-24.275	-118.8	.711	-92.8
1100.00	.522	-133.1	2.179	-89.8	-25.472	-128.5	.765	-108.7
1200.00	.575	-135.9	-.609	-105.1	-26.457	-137.7	.806	-120.2
1300.00	.624	-139.6	-3.362	-116.9	-27.448	-147.4	.815	-130.0
1400.00	.660	-143.2	-6.063	-125.9	-28.277	-156.6	.827	-139.1
1500.00	.683	-147.3	-8.075	-136.5	-28.621	-167.8	.841	-146.6
1600.00	.708	-151.6	-9.429	-144.2	-29.211	-178.9	.858	-152.7
1700.00	.733	-154.9	-9.908	-153.8	-29.815	166.1	.874	-157.7
1800.00	.773	-157.2	-9.395	-168.5	-31.033	155.2	.898	-162.9
1900.00	.816	-160.5	-9.778	170.3	-32.541	151.5	.911	-168.1
2000.00	.848	-165.4	-10.473	146.1	-32.885	150.5	.907	-172.4

Product Options

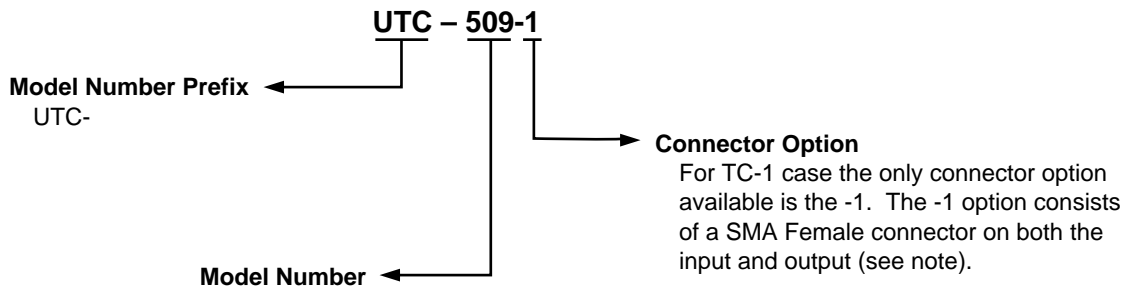
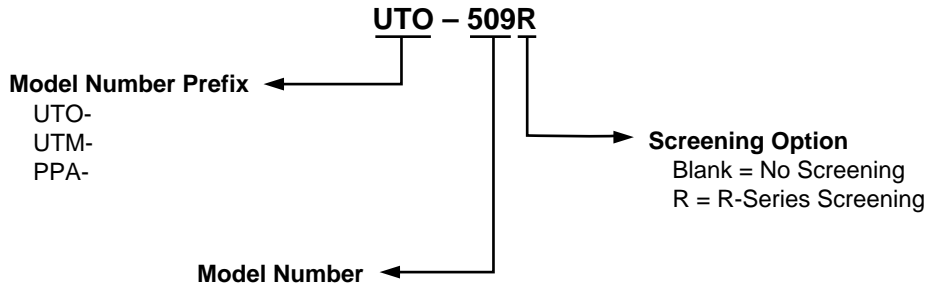

Note: R-Series screening is not available in the TC-1 case as the case is non-hermetic.

Case Drawings TO-8T

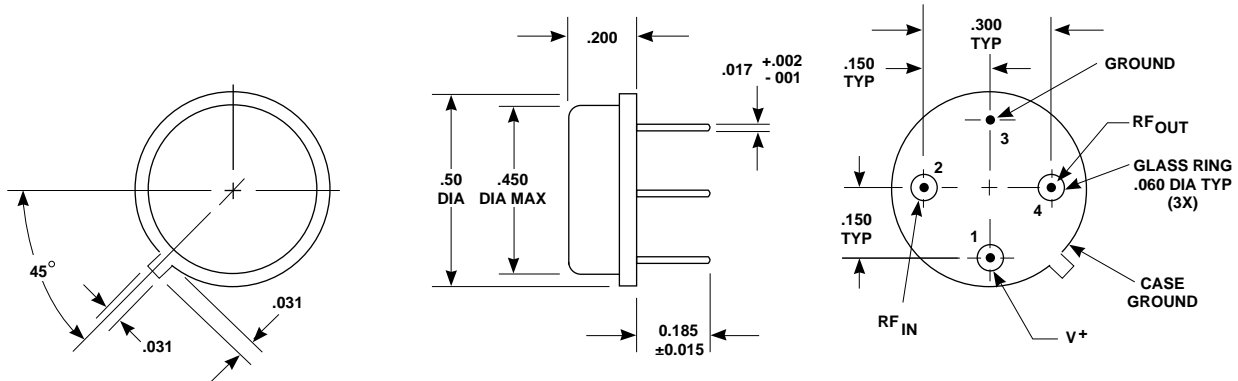

APPROXIMATE WEIGHT 2.1 GRAMS

- NOTES (UNLESS OTHERWISE SPECIFIED):
1. DIMENSIONS ARE SPECIFIED IN INCHES
 2. TOLERANCES: xx ± .02
xxx ± .010

TC-1A

