



# Thin-Film Cascadable Amplifier 5 to 500 MHz

## Technical Data

### UTO/UTC 517 Series

#### Features

- **Frequency Range: 5 to 500 MHz**
- **High Gain: 22.5 dB (Typ)**
- **Low Noise: 2.0 dB (Typ)**
- **Temperature Compensated**
- **Surface Mount Option**

#### Applications

- **IF/RF Amplification**
- **Surface Mount Assembly**

#### Description

The 517 Series is a thin-film high-gain, low-noise RF amplifier that uses resistive feedback and active bias to provide temperature compensation and increased immunity to bias voltage variations. Block-ing capacitors couple the RF through the amplifier. The 517 Series amplifiers are available in three packages: the surface mount PlanarPak PP-38 (.375 in. x .375 in.) case, the TO-8 hermetic case and the connectorized TC-1A case.

#### Pin Configuration

##### UTO—TO-8U

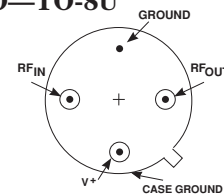

##### UTC—TC-1A

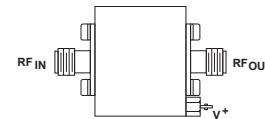

#### Schematic

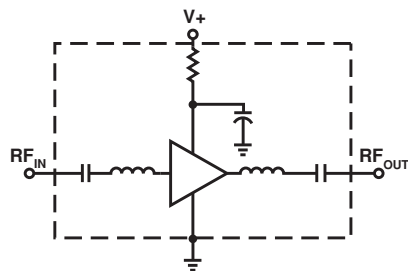

#### Maximum Ratings

Parameter	Maximum
DC Voltage	+17 Volts
Continuous RF Input Power	+13 dBm
Operating Case Temperature	-55 to +125°C
Storage Temperature	-62 to +150°C
"R" Series Burn-In Temperature	+125°C

#### Thermal Characteristics<sup>1</sup>

$\theta_{JC}$	105°C/W
Active Transistor Power Dissipation	170 mW
Junction Temperature Above Case Temperature	18°C
MTBF (MIL-HDBK-217E, $A_{UF}$ @ 90°C)	1,158,000 Hrs.

**Weight:** (typical) PPA—0.5 grams; UTO—2.1 grams; UTC—21.5 grams

## Electrical Specifications

(Measured in 50  $\Omega$  system @ +15 VDC nominal unless otherwise noted)

Symbol	Characteristic	Typical $T_C = 25^\circ\text{C}$	Guaranteed Specifications		Unit
			$T_C = 0 \text{ to } 50^\circ\text{C}$	$T_C = -55 \text{ to } +85^\circ\text{C}$	
BW	Frequency Range	5-500	5-500	5-500	MHz
GP	Small Signal Gain (Min.)	22.5	22.0	21.0	dB
—	Gain Flatness (Max.)	$\pm 0.7$	$\pm 1.0$	$\pm 1.0$	dB
NF	Noise Figure (Max.)	2.0	2.5	3.0	dB
P <sub>1dB</sub>	Power Output @ +1 dB Comp. (Min.)	+6.5	+5.0	+4.0	dBm
—	Input VSWR (Max.)	<1.5:1	2.0:1	2.0:1	—
—	Output VSWR (Max.)	<1.7:1	2.0:1	2.0:1	—
IP <sub>3</sub>	Two Tone 3rd Order Intercept Point	+15.0	—	—	dBm
IP <sub>2</sub>	Two Tone 2nd Order Intercept Point	+22.0	—	—	dBm
HP <sub>2</sub>	One Tone 2nd Harmonic Intercept Point	+27.0	—	—	dBm
I <sub>D</sub>	DC Current	22	—	—	mA

## Typical Performance Over Temperature (@ +15 VDC unless otherwise noted)

Key: +25°C —  
+85°C —  
-55°C —

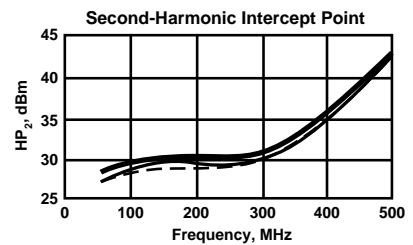
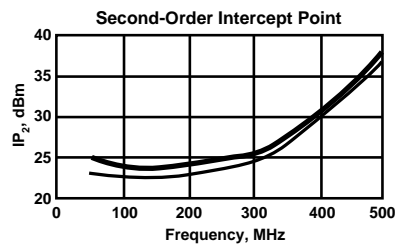
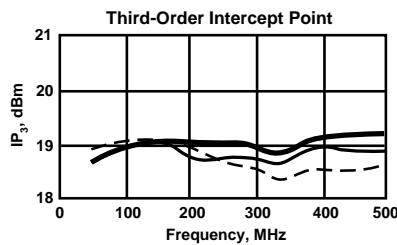
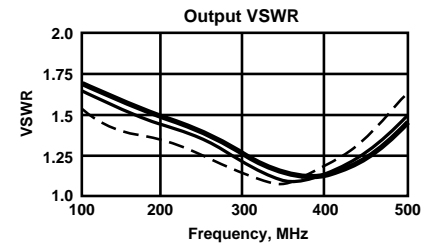
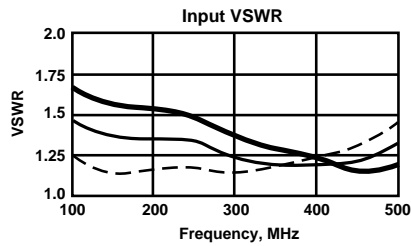
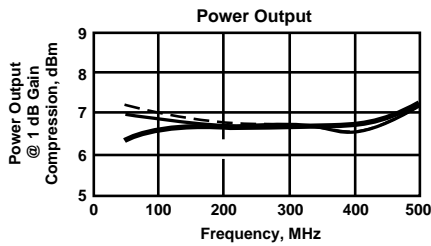
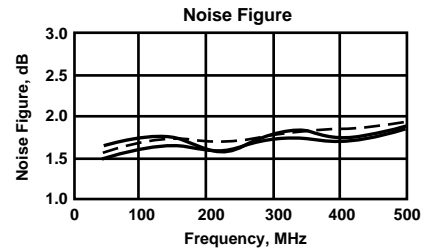
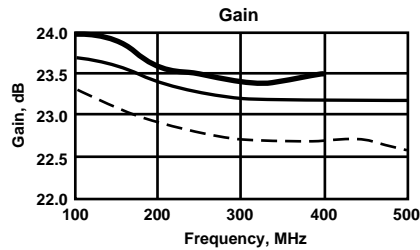

**Automatic Network Analyzer Measurements** (Typical production unit @ +25°C ambient)

**Numerical Readings**
**Bias = 15.00 Volts**

FREQUENCY MHz	VSWR IN	GAIN dB	PHASE DEGREES	GROUP DELAY ns	VSWR OUT	ISOLATION dB
100.0	1.28	22.94	162.63	.00	1.45	30.99
150.0	1.29	23.02	152.17	.53	1.46	31.12
200.0	1.31	23.05	143.42	.49	1.48	31.07
250.0	1.35	23.01	134.43	.51	1.49	31.11
300.0	1.37	22.98	124.92	.54	1.51	31.10
350.0	1.39	22.99	115.09	.55	1.54	31.08
400.0	1.40	22.99	104.99	.58	1.57	31.02
450.0	1.38	22.99	94.37	.61	1.61	31.00
500.0	1.33	22.90	83.14	.63	1.64	30.92
550.0	1.27	22.83	71.63	.65	1.69	30.84
600.0	1.19	22.73	59.82	.66	1.76	30.71
650.0	1.12	22.56	47.78	.69	1.82	30.63
700.0	1.13	22.33	35.10	.70	1.90	30.58
750.0	1.24	22.05	22.51	.70	2.03	30.56
800.0	1.41	21.61	9.98	.72	2.19	30.52
850.0	1.62	20.99	-3.46	.75	2.41	30.50
900.0	1.98	20.29	-17.10	.78	2.73	30.64
950.0	2.22	19.39	-31.45	.81	3.18	30.81
1000.0	2.63	18.26	-46.31	.00	3.72	31.25

**S-Parameters**
**Bias = 15.00 Volts**

FREQUENCY MHz	S <sub>11</sub>		S <sub>21</sub>		S <sub>12</sub>		S <sub>22</sub>	
	Mag	Ang	dB	Ang	dB	Ang	Mag	Ang
100.00	.156	151.8	23.049	164.9	-29.646	11.1	.080	1.4
150.00	.165	134.6	22.612	156.1	31.278	-1.1	.083	-2.8
200.00	.163	117.0	22.681	149.0	-31.053	11.2	.092	-6.1
250.00	.151	106.0	22.747	139.8	-30.067	7.7	.099	-12.5
300.00	.139	92.3	22.790	132.5	-29.378	4.9	.105	-17.7
350.00	.113	85.1	22.901	123.8	-28.143	2.5	.116	-30.6
400.00	.086	74.2	22.835	115.4	-28.370	-9.2	.091	-40.1
450.00	.044	85.4	22.943	106.1	-28.829	-18.9	.103	-64.7
500.00	.040	152.1	22.835	95.6	-29.833	-30.2	.112	-96.1
550.00	.103	170.1	22.789	85.7	-32.217	-33.6	.113	-126.6
600.00	.180	162.9	22.533	73.9	-35.323	-31.2	.110	-154.6
650.00	.258	152.0	21.994	62.9	-37.411	-11.6	.109	-175.3
700.00	.333	139.2	21.359	51.8	-37.387	7.1	.112	169.4
750.00	.397	127.4	20.542	41.2	-36.298	20.2	.121	156.1
800.00	.447	116.4	19.483	31.7	-35.465	25.3	.133	148.6
850.00	.489	106.2	18.590	23.8	-34.078	34.4	.150	140.3
900.00	.523	97.3	17.554	16.5	-33.008	31.6	.170	134.9
950.00	.547	89.7	16.496	10.4	-32.089	39.5	.190	130.3
1000.00	.563	81.9	15.739	4.6	-31.007	39.5	.215	126.9

### Product Options

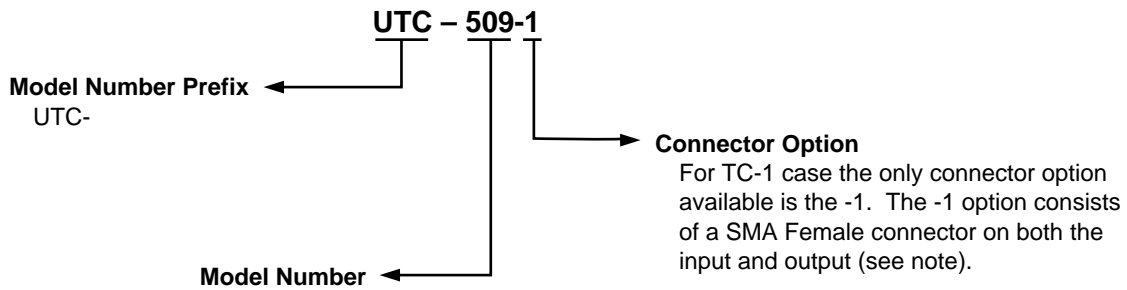
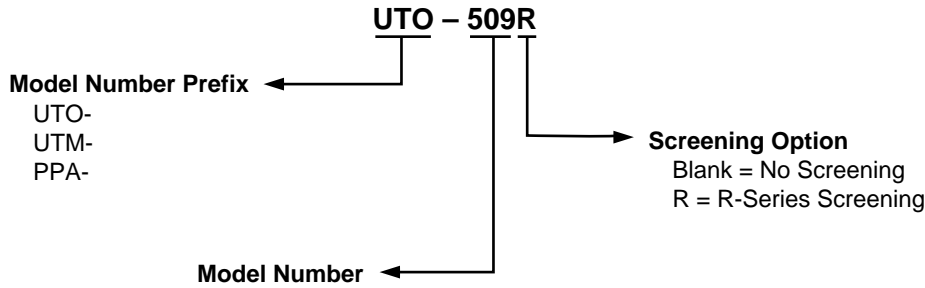

Note: R-Series screening is not available in the TC-1 case as the case is non-hermetic.

### Case Drawings TO-8U

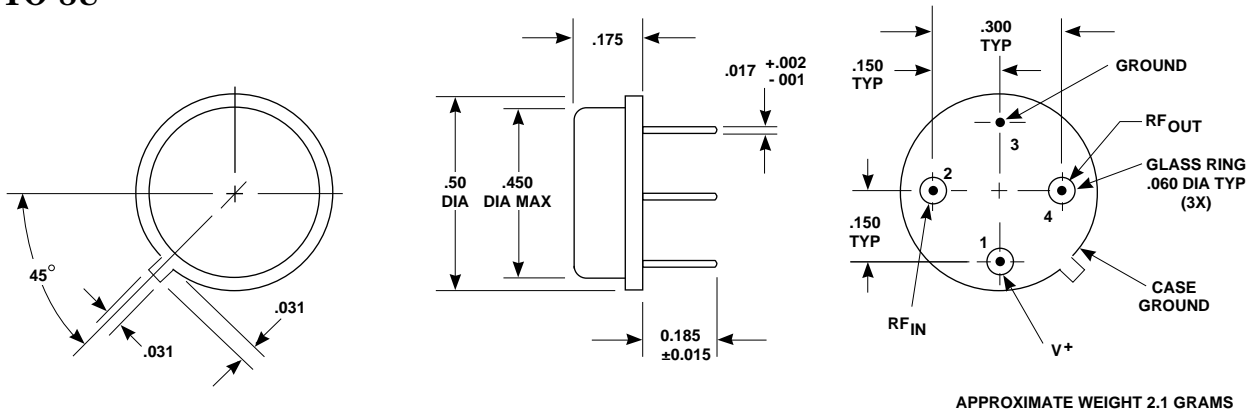

- NOTES (UNLESS OTHERWISE SPECIFIED):  
 1. DIMENSIONS ARE SPECIFIED IN INCHES  
 2. TOLERANCES: xx ± .02  
 xxx ± .010

# TC-1A

