



Thin-Film Cascadable Amplifier 10 to 2000 MHz

Technical Data

UTO/UTC 2023 Series

Features

- **Frequency Range: 10 to 2000 MHz**
- **Medium Output Power: +14.5 dBm (Typ)**
- **Medium Gain: 8.5 dB (Typ)**
- **Temperature Compensated**
- **Surface Mount Option**

Applications

- **IF/RF Amplification**
- **Surface Mount Assembly**

Description

The 2023 Series is a medium-power, wideband thin-film bipolar RF amplifier with resistive feedback and active bias for temperature compensation and increased immunity to bias voltage variations. Input/output blocking capacitors couple the RF through the amplifier, while a low VSWR is maintained through inductive tuning. The 2023 Series amplifiers are available in three packages: the surface mount PlanarPak PP-38 (.375 in. x .375 in.) case, the TO-8 hermetic case and the connectorized TC-1A case.

Pin Configuration

UTO—TO-8T

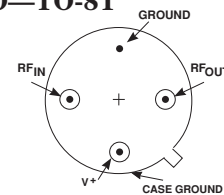

UTC—TC-1A

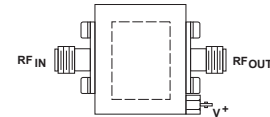

Schematic

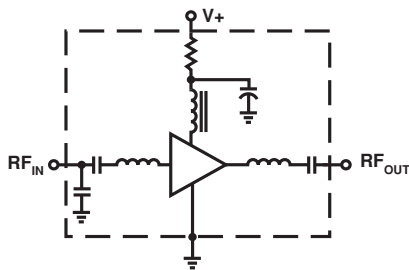

Maximum Ratings

Parameter	Maximum
DC Voltage	+17 Volts
Continuous RF Input Power	+13 dBm
Operating Case Temperature	-55 to +100°C
Storage Temperature	-62 to +150°C
“R” Series Burn-In Temperature	+100°C

Thermal Characteristics¹

θ_{JC}	75°C/W
Active Transistor Power Dissipation	600 mW
Junction Temperature Above Case Temperature	45°C
MTBF (MIL-HDBK-217E, A_{UF} @ 90°C)	664,200 Hrs.

Weight: (typical) UTO—2.1 grams; UTC—21.5 grams

Electrical Specifications

(Measured in 50 Ω system @ +15 VDC nominal unless otherwise noted)

Symbol	Characteristic	Typical $T_C = 25^\circ\text{C}$	Guaranteed Specifications		Unit
			$T_C = 0$ to 50°C	$T_C = -55$ to $+85^\circ\text{C}$	
BW	Frequency Range	10-2000	10-2000	10-2000	MHz
GP	Small Signal Gain (Min.)	8.5	8.0	7.5	dB
—	Gain Flatness (Max.)	± 0.5	± 1.0	± 1.0	dB
NF	Noise Figure (Max.)	6.5	8.5	9.5	dB
P _{1dB}	Power Output @ +1 dB Comp. (Min.)	+14.5	+14.0	+14.0	dBm
—	Input VSWR (Max.)	<1.8:1	2.2:1	2.2:1	—
—	Output VSWR (Max.)	<1.5:1	2.2:1	2.2:1	—
IP ₃	Two Tone 3rd Order Intercept Point	+25.0	—	—	dBm
IP ₂	Two Tone 2nd Order Intercept Point	+40.0	—	—	dBm
HP ₂	One Tone 2nd Order Intercept Point	+46.0	—	—	dBm
I _D	DC Current	50	—	—	mA

Typical Performance Over Temperature (@ +15 VDC unless otherwise noted)

Key: +25°C —
+85°C - -
-55°C —

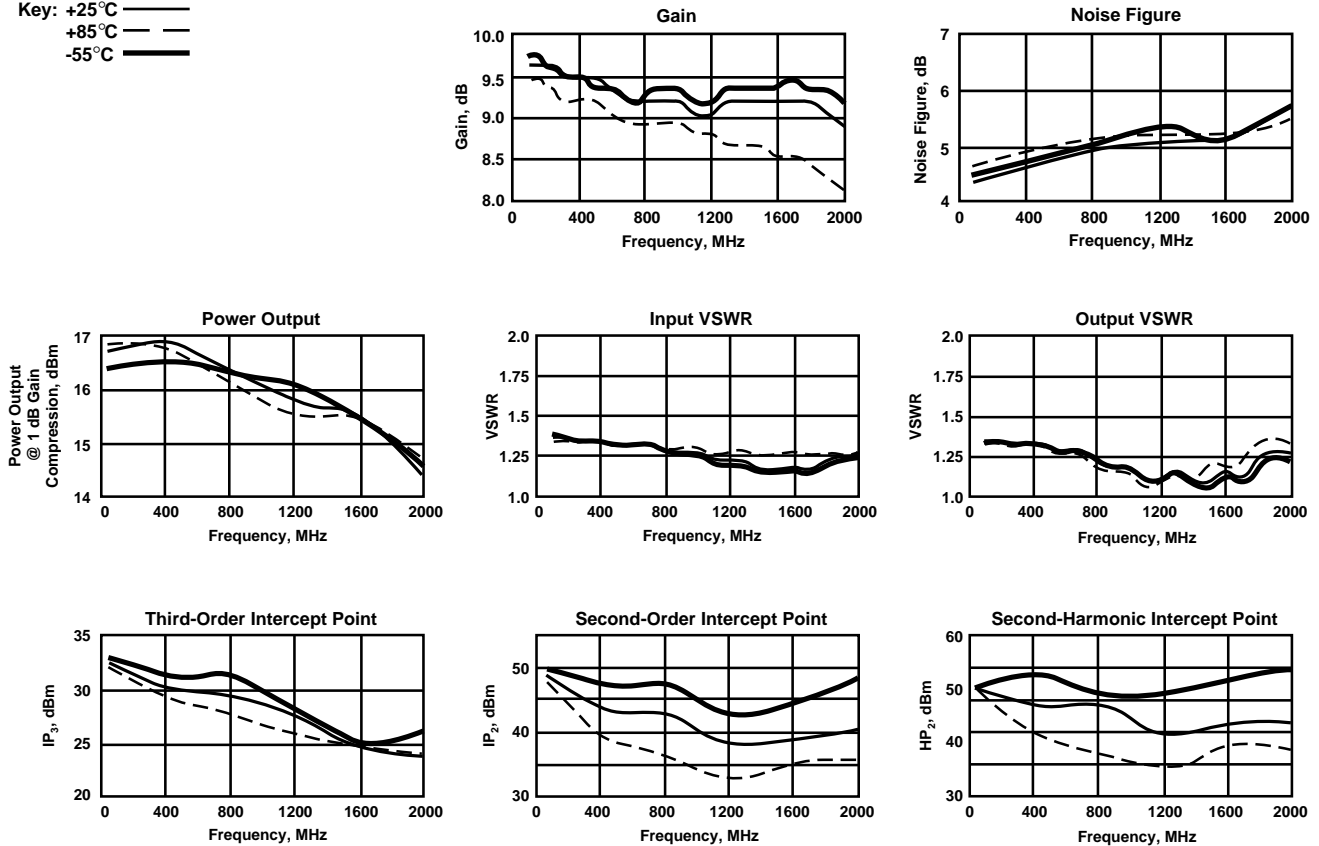

Automatic Network Analyzer Measurements (Typical production unit @ +25°C ambient)**Numerical Readings****Bias = 15.00 Volts**

FREQUENCY MHz	VSWR IN	GAIN dB	PHASE DEGREES	PHASE DEV	GROUP DELAY ns	VSWR OUT	ISOLATION dB
100.0	1.59	9.08	168.15	-1.16	.00	1.48	15.29
200.0	1.61	9.03	156.52	-1.27	.33	1.47	15.34
300.0	1.63	8.96	144.62	-1.67	.33	1.46	15.38
400.0	1.66	8.97	132.82	-1.96	.31	1.45	15.51
500.0	1.69	8.98	121.76	-1.51	.30	1.44	15.61
600.0	1.73	8.94	110.90	-.85	.30	1.42	15.72
700.0	1.75	8.86	100.15	-.10	.28	1.40	15.82
800.0	1.78	8.80	90.08	1.35	.31	1.37	15.92
900.0	1.78	8.75	79.14	1.92	.31	1.35	16.01
1000.0	1.79	8.71	68.05	2.34	.31	1.32	16.07
1200.0	1.76	8.67	45.08	2.40	.32	1.31	16.25
1400.0	1.69	8.63	21.55	1.91	.33	1.35	16.36
1600.0	1.58	8.65	-2.46	.94	.34	1.46	16.32
1800.0	1.43	8.59	-28.04	-1.60	.37	1.60	16.29
2000.0	1.23	8.56	-55.05	-5.57	.38	1.73	16.22
2200.0	1.14	8.14	-82.83	—	.40	1.79	16.21
2400.0	1.49	7.29	-112.71	—	.43	1.79	16.39

S-Parameters**Bias = 15.00 Volts**

FREQUENCY MHz	S ₁₁		S ₂₁		S ₁₂		S ₂₂	
	Mag	Ang	dB	Ang	dB	Ang	Mag	Ang
100.00	.241	-178.1	8.611	168.7	-15.091	-6.1	.182	161.6
200.00	.242	-178.7	8.589	157.1	-15.207	-13.1	.179	147.1
300.00	.247	-179.7	8.543	145.5	-15.262	-19.4	.181	131.2
400.00	.250	179.3	8.575	133.8	-15.409	-25.3	.182	116.6
500.00	.258	178.0	8.614	122.9	-15.473	-31.7	.180	103.3
600.00	.263	176.9	8.613	112.3	-15.547	-38.0	.176	89.5
700.00	.272	175.1	8.621	101.7	-15.677	-44.3	.168	75.3
800.00	.277	172.8	8.619	91.6	-15.779	-50.1	.161	60.4
900.00	.282	170.3	8.630	80.7	-15.773	-55.0	.149	44.2
1000.00	.283	168.1	8.663	69.5	-15.849	-61.0	.139	25.0
1200.00	.275	162.2	8.758	46.2	-16.031	-73.1	.128	-18.9
1400.00	.249	154.1	8.886	22.2	-16.145	-85.6	.139	-85.7
1600.00	.200	143.2	9.013	-2.8	-16.116	-98.1	.167	-107.1
1800.00	.119	126.5	9.059	-29.8	-16.163	-110.6	.191	-143.6
2000.00	.026	27.6	9.063	-58.5	-16.245	-124.1	.209	-178.0
2200.00	.164	-60.6	8.539	-87.8	-16.442	-139.7	.219	144.2
2400.00	.330	-83.0	7.508	-118.7	-16.906	-156.7	.227	109.4

Product Options

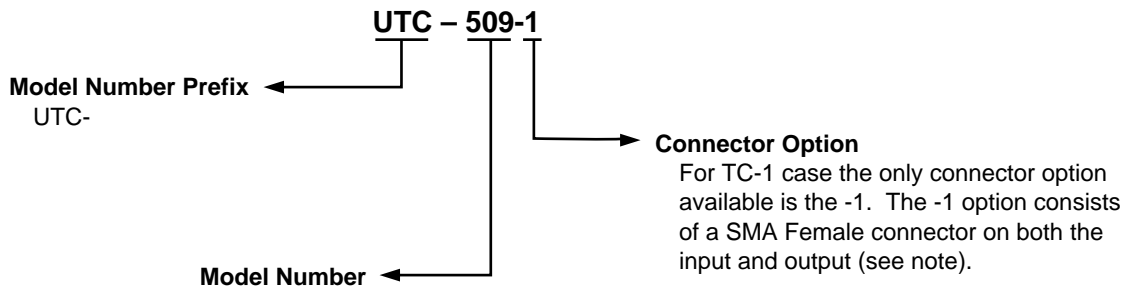
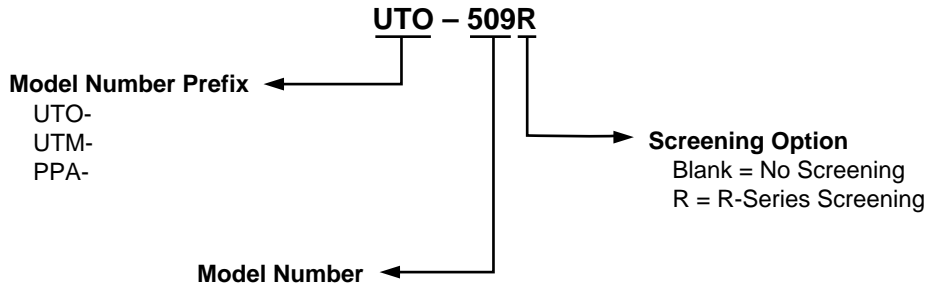

Note: R-Series screening is not available in the TC-1 case as the case is non-hermetic.

Case Drawings TO-8T

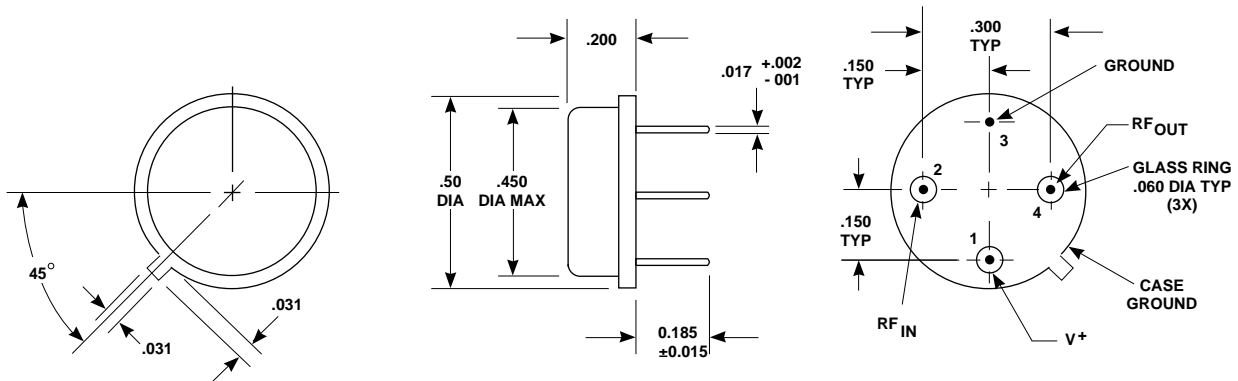

APPROXIMATE WEIGHT 2.1 GRAMS

- NOTES (UNLESS OTHERWISE SPECIFIED):
 1. DIMENSIONS ARE SPECIFIED IN INCHES
 2. TOLERANCES: xx ± .02
 xxx ± .010

Case Drawings TC-1

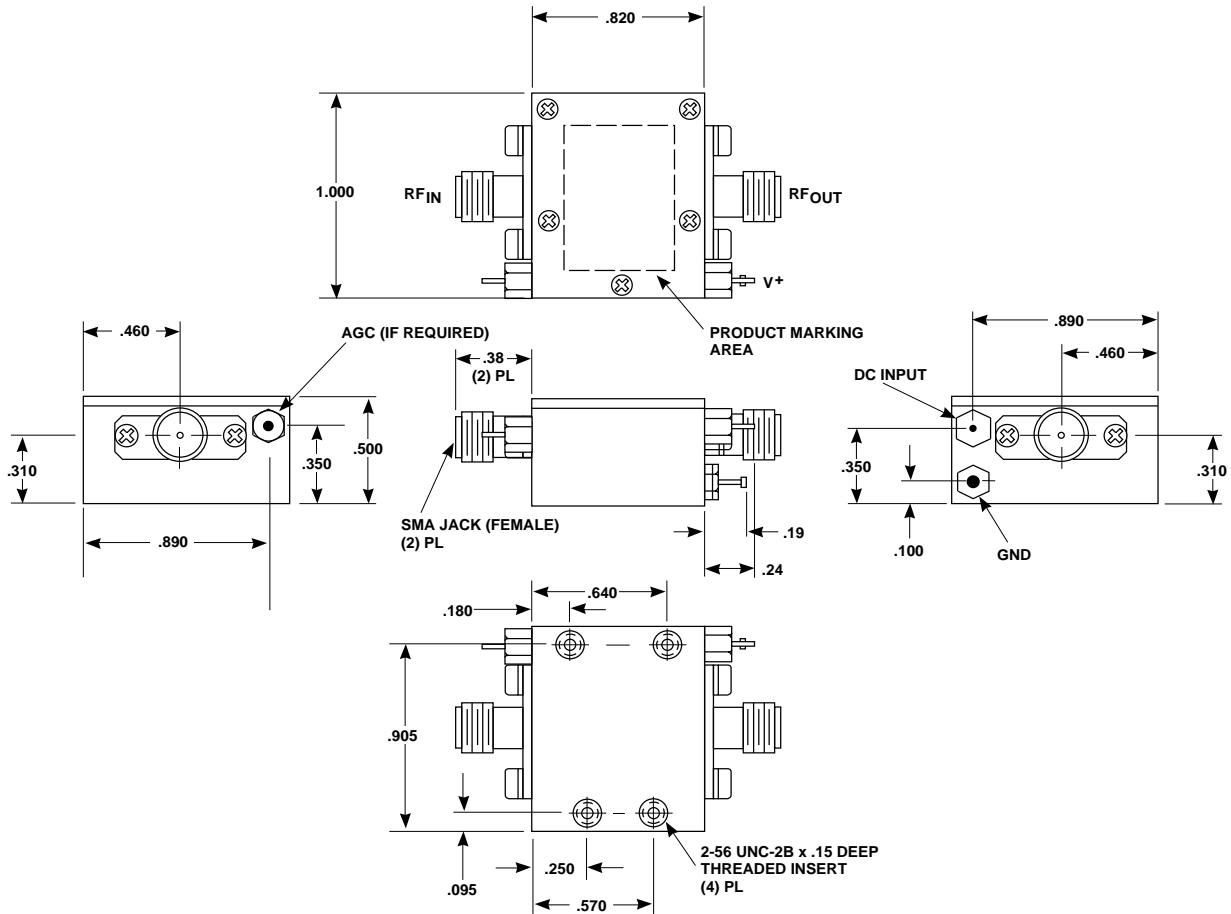

TYPICAL WEIGHT WITH CONNECTORS = 21.5 GRAMS

NOTES: 1. THE TC-1 CASE IS A NON-HERMETIC CASE.
2. THE ONLY CONNECTOR OPTION AVAILABLE FOR THE TC-1 CASE IS THE -1, SMA FEMALE CONNECTORS AT BOTH INPUT AND OUTPUT PORTS.

NOTES (UNLESS OTHERWISE SPECIFIED):
1. DIMENSIONS ARE SPECIFIED IN INCHES
2. TOLERANCES: xx ± .02
xxx ± .010

Contact Teledyne Microwave Solutions:
650-691-9800
650-962-6845 fax

Check for updates:
www.teledynemicrowave.com