



Thin-Film Cascadable Amplifier 1700 to 2300 MHz

Technical Data

UTO/UTC 2302 Series

Features

- **Frequency Range: 1700 to 2300 MHz**
- **Medium Gain: 10.5 dB (Typ)**
- **Low VSWR**
- **Temperature Compensated**

Applications

- **IF/RF Amplification**
- **Telemetry**
- **Military Communications**

Description

The 2302 Series is a thin-film bipolar RF amplifier that incorporates resistive feedback and active bias for temperature compensation and Increased Immunity to bias voltage variations. Tuned inductive coupling maintains low VSWR over all conditions, while blocking capacitors couple RF through the amplifier. The 2302 Series amplifiers are available in either the TO-8 hermetic case or connected TC-1A package.

Pin Configuration

UTO—TO-8U

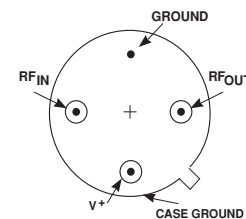

UTC—TC-1A

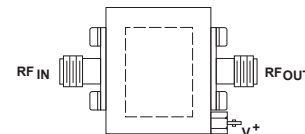

Schematic

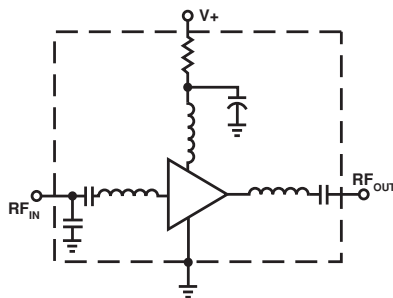

Maximum Ratings

Parameter	Maximum
DC Voltage	+17 Volts
Continuous RF Input Power	+13 dBm
Operating Case Temperature	-55 to +125°C
Storage Temperature	-62 to +150°C
"R" Series Burn-In Temperature	+125°C

Thermal Characteristics¹

θ_{JC}	105°C/W
Active Transistor Power Dissipation	130 mW
Junction Temperature Above Case Temperature	14°C
MTBF (MIL-HDBK-217E, A_{UF} @ 90°C)	752,100 Hrs.

Weight: (typical) UTO—2.1 grams; UTC—21.5 grams

Electrical Specifications

(Measured in 50 Ω system @ +15 VDC nominal unless otherwise noted)

Symbol	Characteristic	Typical $T_C = 25^\circ\text{C}$	Guaranteed Specifications		Unit
			$T_C = 0 \text{ to } 50^\circ\text{C}$	$T_C = -55 \text{ to } +85^\circ\text{C}$	
BW	Frequency Range	1700-2300	1700-2300	1700-2300	MHz
GP	Small Signal Gain (Min.)	10.5	8.0	8.0	dB
—	Gain Flatness (Max.)	± 0.3	± 0.5	± 1.0	dB
NF	Noise Figure (Max.)	5.0	6.5	7.0	dB
P_{1dB}	Power Output @ +1 dB Comp. (Min.)	+8.0	+3.0	+2.0	dBm
—	Input VSWR (Max.)	<1.5:1	2.0:1	2.0:1	—
—	Output VSWR (Max.)	<1.5:1	2.0:1	2.0:1	—
IP_3	Two Tone 3rd Order Intercept Point	+13.0	—	—	dBm
IP_2	Two Tone 2nd Order Intercept Point	+23.0	—	—	dBm
HP_2	One Tone 2nd Harmonic Intercept Point	+27.0	—	—	dBm
I_D	DC Current	18	—	—	mA

Typical Performance Over Temperature (@ +15 VDC unless otherwise noted)

Key: +25°C —
+85°C - -
-55°C —

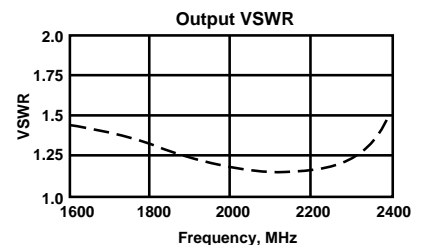
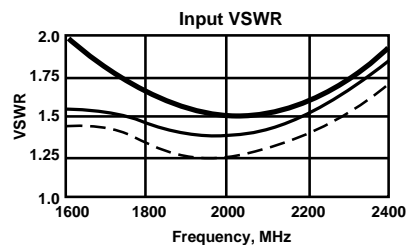
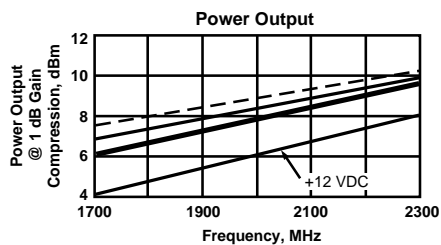
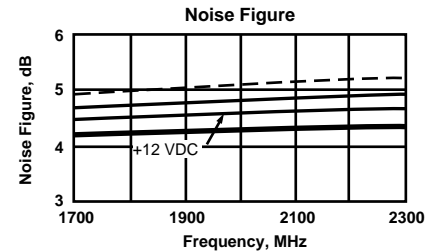
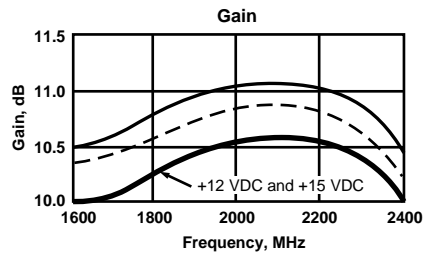

Automatic Network Analyzer Measurements (Typical production unit @ +25°C ambient)

Numerical Readings
Bias = 15.00 Volts

FREQUENCY MHz	VSWR IN	GAIN dB	PHASE DEGREES	PHASE DEV	GROUP DELAY ns	VSWR OUT	ISOLATION dB
400.0	4.43	8.86	-156.61	—	.98	2.04	28.14
600.0	2.46	10.44	171.17	—	.80	1.85	26.08
600.0	1.91	10.94	145.35	—	.62	1.69	25.26
700.0	1.77	10.97	125.73	—	.49	1.61	24.76
600.0	1.76	10.74	109.58	—	.43	1.56	24.39
900.0	1.81	10.57	94.94	—	.39	1.54	24.04
1000.0	1.84	10.42	81.39	—	.36	1.51	23.61
1100.0	1.86	10.34	68.28	—	.36	1.50	23.22
1200.0	1.88	10.26	55.71	—	.35	1.49	22.75
1300.0	1.88	10.24	43.20	—	.35	1.48	22.27
1400.0	1.85	10.28	30.46	—	.35	1.46	21.75
1500.0	1.83	10.35	17.82	—	.35	1.45	21.31
1600.0	1.79	10.48	5.16	—	.36	1.43	20.82
1700.0	1.76	10.56	-7.87	-1.72	.37	1.40	20.39
1800.0	1.70	10.70	-21.84	-.14	.40	1.36	19.91
1900.0	1.66	10.83	-36.58	.64	.42	1.31	19.44
2000.0	1.61	11.01	-51.95	.89	.42	1.23	19.06
2100.0	1.60	11.08	-67.17	1.12	.44	1.13	18.79
2200.0	1.87	11.00	-83.76	.09	.48	1.07	18.68
2300.0	1.82	10.77	-101.62	-2.21	.50	1.19	18.78
2400.0	2.15	10.37	-119.98	—	.53	1.39	19.11
2500.0	2.63	9.70	-139.72	—	.55	1.65	19.83

Linearization Range: 1700 to 2300 MHz

S-Parameters
Bias = 15.00 Volts

FREQUENCY MHz	S ₁₁		S ₂₁		S ₁₂		S ₂₂	
	Mag	Ang	dB	Ang	dB	Ang	Mag	Ang
300.00	.861	-152.9	3.553	-121.6	-34.830	104.4	.385	-101.6
400.00	.646	172.4	9.381	-162.3	-27.922	71.3	.371	-133.9
500.00	.473	154.6	10.645	168.1	-26.023	49.1	.343	-162.7
600.00	.376	146.4	11.003	143.8	-24.958	35.8	.316	171.8
700.00	.334	143.1	10.994	125.5	-24.390	25.2	.306	150.1
800.00	.315	142.1	10.845	111.4	-24.007	19.9	.297	134.1
900.00	.309	138.9	10.660	96.8	-23.482	12.3	.292	118.1
1000.00	.308	135.0	10.532	82.9	-22.964	5.9	.282	102.9
1100.00	.308	129.8	10.448	68.9	-22.519	-1.5	.273	88.6
1200.00	.311	125.4	10.387	58.7	-z.030	-6.6	.261	77.6
1300.00	.306	118.5	10.370	44.9	-21.646	-13.7	.246	61.9
1400.00	.300	110.4	10.385	30.9	-21.169	-20.8	.228	46.3
1500.00	.289	102.8	10.464	18.3	-20.586	-27.9	.210	30.6
1600.00	.277	94.1	10.570	6.4	-20.267	-34.5	.191	15.0
1700.00	.260	83.9	10.651	-5.5	-19.850	-40.9	.175	-1.8
1800.00	.237	69.0	10.722	-21.6	-19.375	-50.8	.152	-25.2
1900.00	.212	53.5	10.779	-35.5	-18.936	-59.8	.134	-46.3
2000.00	.189	36.9	10.933	-46.8	-18.575	-66.2	.120	-65.4
2100.00	.168	7.1	10.967	-63.1	-18.248	-77.0	.095	-93.3
2200.00	.179	-31.4	10.927	-80.3	-18.106	-98.6	.067	-132.0
2300.00	.224	-64.6	10.682	-96.8	-18.000	-100.7	.051	161.5
2400.00	.297	-90.2	10.376	-113.5	-18.096	-113.4	.083	99.2
2500.00	.390	-112.3	9.817	-131.6	-18.622	-126.6	.146	60.3
2600.00	.490	-132.8	8.981	-151.6	-19.486	-142.1	.226	32.3
2700.00	.604	-155.1	7.713	-175.9	-20.859	-163.0	.319	5.6
2800.00	.672	-168.4	6.392	169.4	-22.149	-173.9	.377	-10.5
2900.00	.751	171.9	4.344	145.9	-24.913	167.6	.440	-33.2
3000.00	.792	161.5	2.636	132.5	-27.657	154.4	.467	-46.3

Product Options

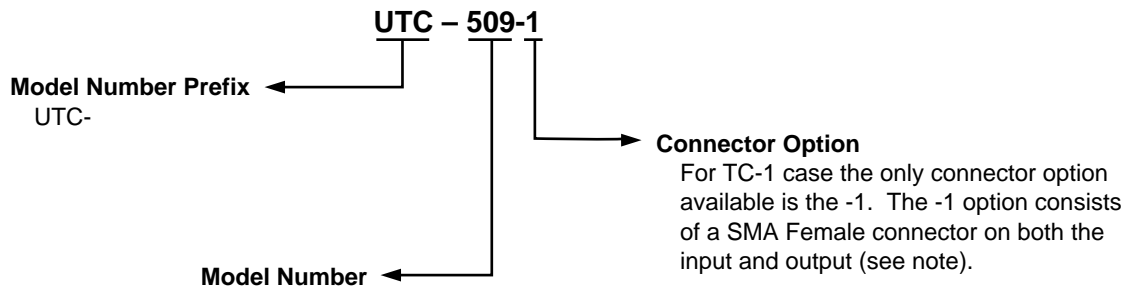
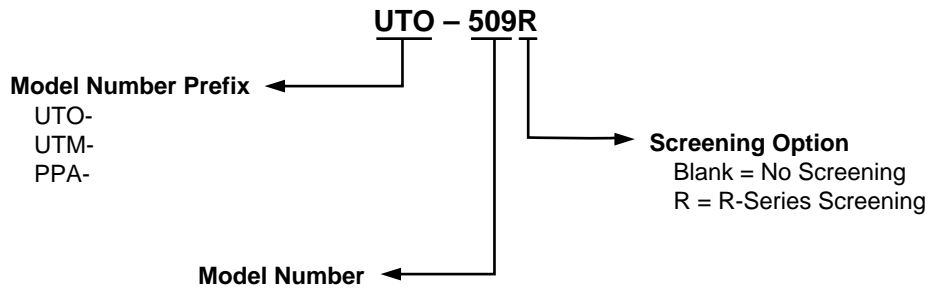

Note: R-Series screening is not available in the TC-1 case as the case is non-hermetic.

**Case Drawings
TO-8U**

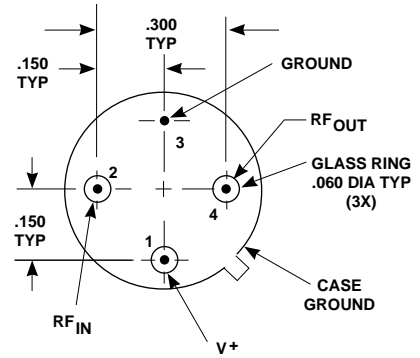
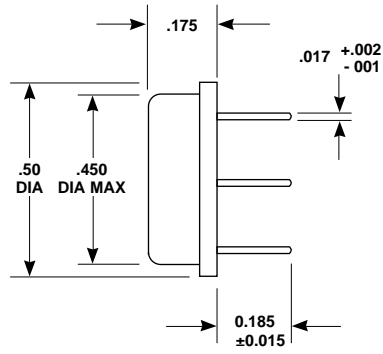
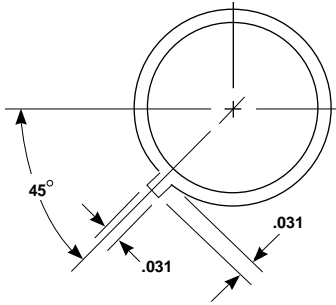

APPROXIMATE WEIGHT 2.1 GRAMS

- NOTES (UNLESS OTHERWISE SPECIFIED):**
 1. DIMENSIONS ARE SPECIFIED IN INCHES
 2. TOLERANCES: xx \pm .02
 xxx \pm .010

Case Drawings TC-1

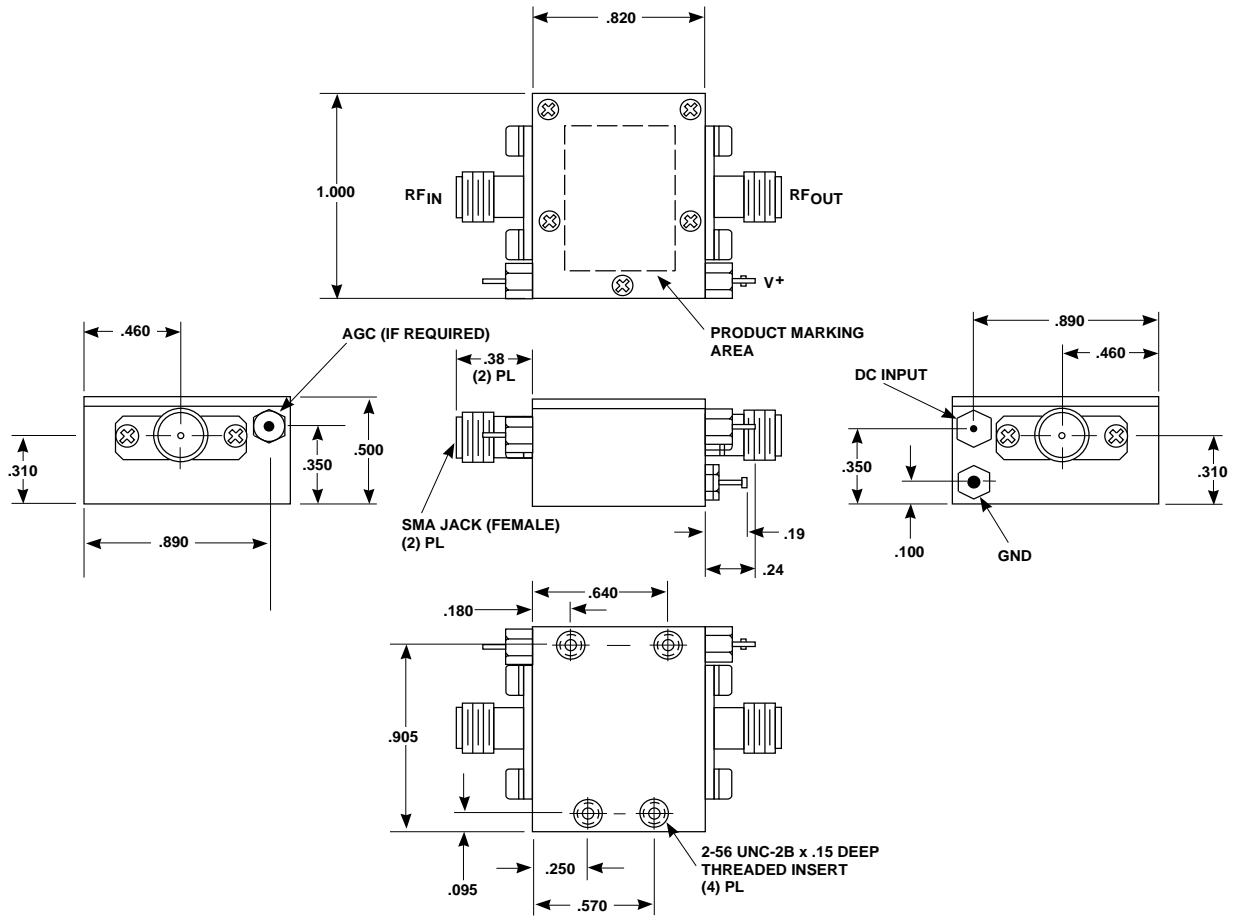

TYPICAL WEIGHT WITH CONNECTORS = 21.5 GRAMS

NOTES: 1. THE TC-1 CASE IS A NON-HERMETIC CASE.
2. THE ONLY CONNECTOR OPTION AVAILABLE FOR THE TC-1 CASE IS THE -1, SMA FEMALE CONNECTORS AT BOTH INPUT AND OUTPUT PORTS.

NOTES (UNLESS OTHERWISE SPECIFIED):
1. DIMENSIONS ARE SPECIFIED IN INCHES
2. TOLERANCES: xx ± .02
xxx ± .010

Contact Teledyne Microwave Solutions:
650-691-9800
650-962-6845 fax

Check for updates:
www.teledynemicrowave.com