



Thin-Film Cascadable Amplifier 10 to 1500 MHz

Technical Data

UTO/UTC/PSA 1509 Series

Features

- **Low Distortion:**
 $IP_3 = +35 \text{ dBm (Typ)}$
- **Frequency Range:** 10 to 1500 MHz
- **High Power Output:**
 $+23 \text{ dBm (Typ)}$
- **Low Noise Figure:**
 2.5 dB (Typ)
- **Medium Gain:** 13.0 dB (Typ)

Applications

- IF/RF Amplification
- Output or Driver Stage
- Instrumentation

Description

The 1509 Series is a thin-film GaAs FET RF amplifier for high output power and low noise applications up to 1500 MHz. Low VSWR is maintained by resistive feedback and inductive tuning while the RF is coupled through the amplifier by internal blocking capacitors. The 1509 Series amplifiers are available in the TO-8, SM-45 hermetic cases or connected TC-1A package.

Pin Configuration

UTO—TO-8T

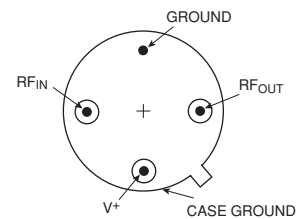

PSA—SM-45

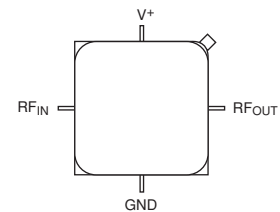

UTC—TC-1A

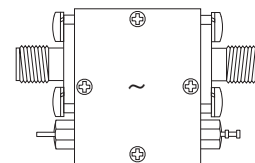

Schematic

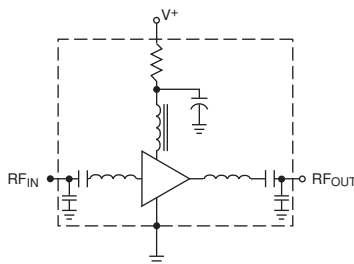

Maximum Ratings

Parameter	Maximum
DC Voltage	+17 Volts
Continuous RF Input Power	+27 dBm
Operating Case Temperature	-55 to +85°C
Storage Temperature	-62 to +150°C
"R" Series Burn-In Temperature	+125°C

Thermal Characteristics

θ_{JC}	39°C/W
Active Transistor Power Dissipation	1.0 W
Junction Temperature Above Case Temperature	39°C
MTBF (MIL-HDBK-217F, A_{UF} @ 75°C)	1,007,690 Hrs.
T_{CH} Max.	175°C

Weight: (typical) UTO—2.1 grams; SM-45—1.7 grams; UTC—21.5 grams

Electrical Specifications

(Measured in 50 Ω system @ +15 VDC nominal unless otherwise noted)

Symbol	Characteristic	Typical $T_C = 25^\circ\text{C}$	Guaranteed Specifications		Unit
			$T_C = 0$ to 50°C	$T_C = -55$ to $+85^\circ\text{C}$	
BW	Frequency Range	10–1500	10–1500	10–1500	MHz
GP	Small Signal Gain (Min.)	12.0	11.5	11.0	dB
—	Gain Flatness (Max.)	± 0.5	± 1.0	± 1.0	dB
NF	Noise Figure (Max.)	2.5*	3.0*	3.5*	dB
P_{1dB}	Power Output @ +1 dB Comp. (Min.)	+23.0	+22.0	+20.0	dBm
—	Input VSWR (Max.)	2.0:1	2.2:1	2.2:1	—
—	Output VSWR (Max.)	2.0:1	2.2:1	2.2:1	—
IP_3	Two Tone 3rd Order Intercept Point	+35.0	—	—	dBm
IP_2	Two Tone 2nd Order Intercept Point	+55.0	—	—	dBm
HP_2	One Tone 2nd Harmonic Intercept Point	+60.0	—	—	dBm
I_D	DC Current	100	—	—	mA

* Specification applies at F greater than 100 MHz; NF @ 10 MHz = 8 dB typical.

Typical Performance Over Temperature (@ +15 VDC unless otherwise noted)

Key: +25°C —
+85°C - - -
-55°C = = =

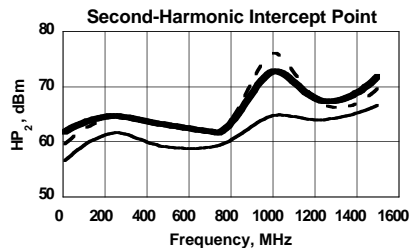
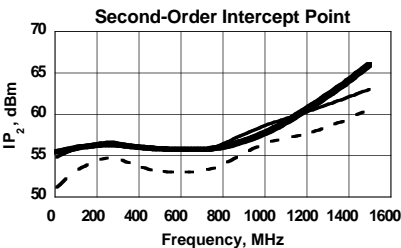
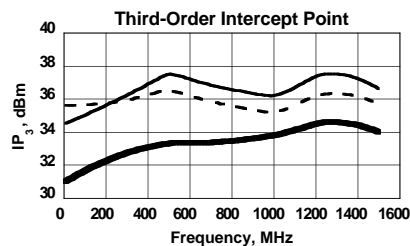
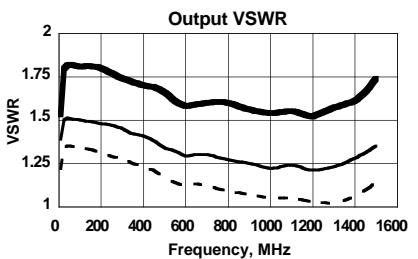
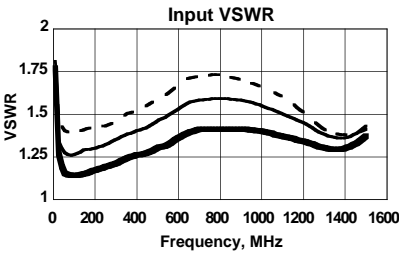
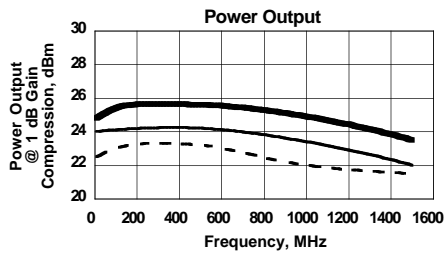
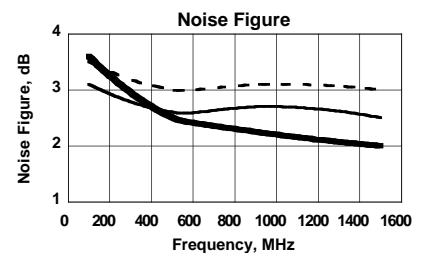
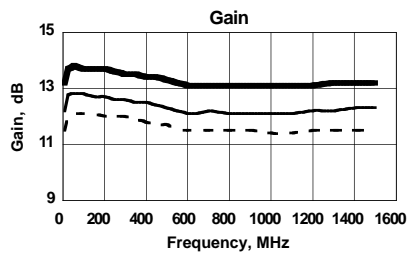

Automatic Network Analyzer Measurements (Typical production unit @ 25°C ambient)**S-Parameters****Bias = 15.00 Volts**

FREQ MHz	S ₁₁		S ₂₁		S ₁₂		S ₂₂		GPDEL ns	PHASE DEV
	Mag	Ang	dB	Ang	dB	Ang	Mag	Ang		
5.0	0.382	-45.0	11.342	-143.2	-17.576	2.7	0.105	-50.2	10.02	
10.0	0.237	-47.3	12.402	-161.2	-19.016	-4.4	0.163	-127.7	6.98	14.46
15.0	0.183	-43.9	12.647	-168.3	-19.487	-5.0	0.180	-146.9	3.10	8.03
20.0	0.157	-40.2	12.734	-172.4	-19.672	-4.6	0.185	-156.3	1.90	4.62
25.0	0.144	-37.0	12.774	-175.2	-19.789	-4.5	0.188	-162.1	1.33	2.51
30.0	0.136	-34.4	12.794	-177.2	-19.860	-4.4	0.189	-165.9	0.98	1.15
35.0	0.131	-32.7	12.807	-178.7	-19.903	-4.6	0.191	-169.3	0.83	.32
40.0	0.127	-31.3	12.816	179.8	-19.912	-4.8	0.190	-171.8	0.78	-.50
45.0	0.125	-30.6	12.809	178.5	-19.954	-4.8	0.191	-173.4	0.68	-1.18
50.0	0.123	-30.4	12.830	177.4	-19.984	-5.0	0.190	-175.1	0.49	-1.63
100.0	0.119	-33.4	12.803	168.8	-19.987	-7.9	0.189	175.0	0.44	-3.62
150.0	0.124	-41.2	12.753	161.5	-20.031	-11.8	0.185	168.6	0.39	-4.25
200.0	0.129	-50.4	12.722	154.8	-20.031	-15.0	0.180	163.2	0.37	-4.42
250.0	0.135	-59.3	12.666	148.1	-20.074	-18.5	0.176	158.2	0.37	-4.46
300.0	0.143	-67.2	12.623	141.6	-20.114	-21.5	0.170	153.3	0.36	-4.40
350.0	0.151	-75.2	12.576	135.2	-20.147	-25.2	0.164	148.7	0.35	-4.13
400.0	0.159	-82.4	12.503	128.9	-20.222	-28.8	0.155	144.0	0.35	-3.80
450.0	0.167	-89.1	12.416	122.6	-20.218	-32.0	0.147	139.0	0.35	-3.51
500.0	0.174	-95.0	12.325	116.2	-20.230	-35.5	0.137	134.6	0.34	-3.24
600.0	0.196	-106.9	12.139	104.5	-20.129	-43.0	0.112	131.8	0.33	-1.81
700.0	0.209	-121.6	12.183	92.8	-20.281	-51.2	0.112	128.6	0.34	-.27
800.0	0.212	-133.8	12.164	80.2	-20.353	-58.7	0.103	119.5	0.35	.36
900.0	0.211	-145.7	12.108	67.6	-20.468	-65.8	0.090	110.3	0.35	1.00
1000.0	0.204	-158.1	12.075	55.0	-20.469	-73.8	0.078	102.8	0.35	1.66
1100.0	0.193	-172.4	12.082	42.3	-20.503	-81.6	0.070	92.9	0.36	2.15
1200.0	0.177	170.8	12.086	29.1	-20.507	-90.9	0.069	82.2	0.37	2.26
1300.0	0.159	148.9	12.082	15.8	-20.517	-99.6	0.069	67.9	0.38	2.11
1400.0	0.147	118.8	12.142	1.6	-20.545	-109.4	0.082	50.5	0.40	1.15
1500.0	0.160	82.2	12.152	-13.4	-20.586	-120.3	0.101	33.2	0.43	-.55
1600.0	0.208	47.9	12.099	-29.1	-20.696	-132.4	0.134	14.6	0.45	
1700.0	0.290	20.6	11.964	-45.8	-20.849	-145.1	0.178	-2.6	0.48	
1800.0	0.395	-1.4	11.638	-63.6	-21.284	-159.0	0.234	-20.6	0.50	
1900.0	0.506	-20.6	11.089	-81.8	-21.908	-173.6	0.294	-37.5	0.51	
2000.0	0.615	-37.8	10.315	-100.1	-22.874	171.8	0.355	-55.3	0.49	
2200.0	0.781	-66.9	7.951	-135.2	-25.568	143.6	0.454	-87.8	0.46	
2400.0	0.872	-89.9	4.996	-166.1	-29.162	120.5	0.512	-116.5	0.40	
2600.0	0.911	-107.4	1.710	166.9	-33.519	102.3	0.534	-142.2	0.35	
2800.0	0.925	-121.5	-1.669	142.9	-38.346	86.9	0.529	-165.7	0.33	

LINEARIZATION RANGE: 10.0 to 1500.0 MHz

Product Options

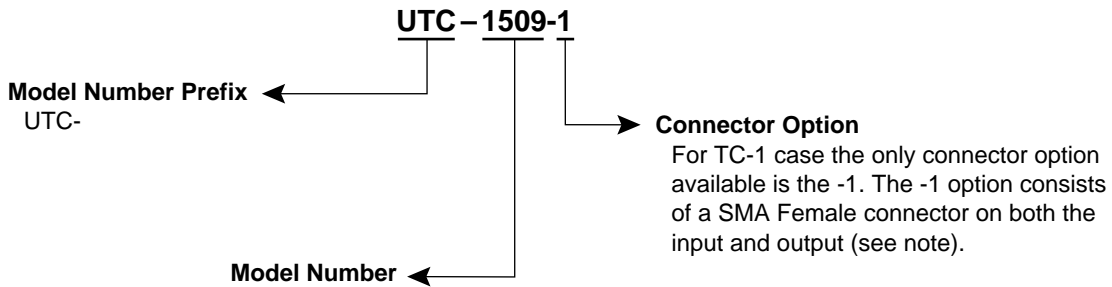
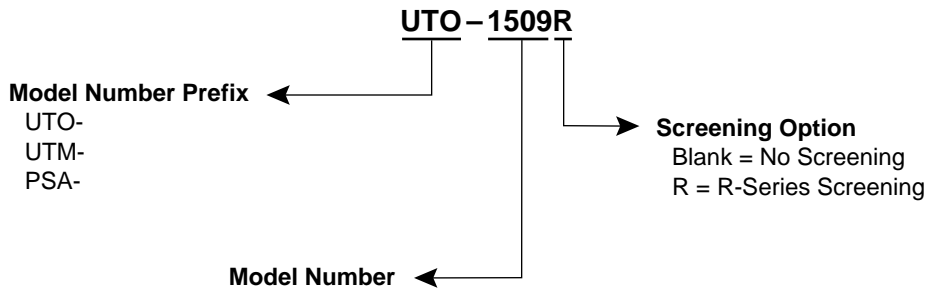

Note: R-Series screening is not available in the TC-1 case as the case is non-hermetic.

**Case Drawings
TO-8T**

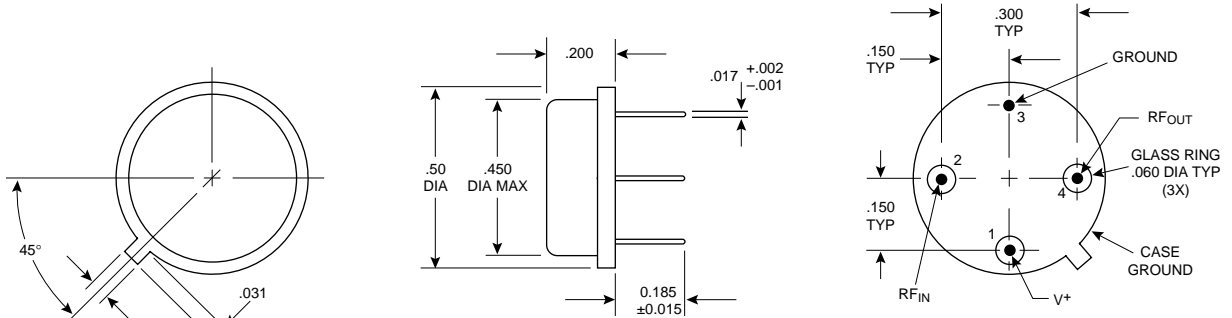

APPROXIMATE WEIGHT 2.1 GRAMS

- NOTES (UNLESS OTHERWISE SPECIFIED):**
1. DIMENSIONS ARE SPECIFIED IN INCHES
2. TOLERANCES: xx ±.02
xxx ±.010

SM-45

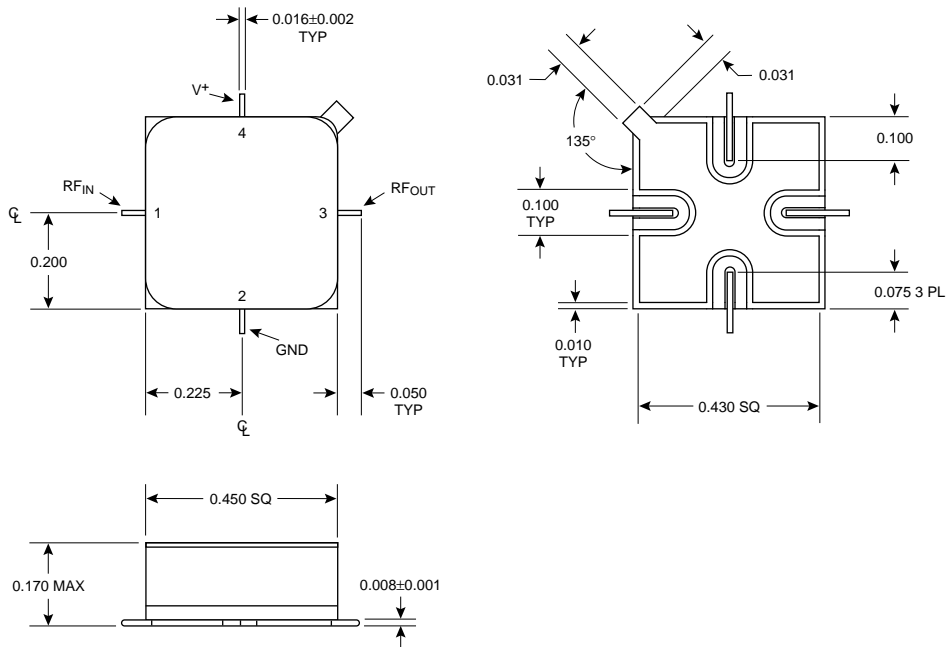

APPROXIMATE WEIGHT 1.7 GRAMS TYPICAL

- NOTES (UNLESS OTHERWISE SPECIFIED):**
1. MAXIMUM TEMPERATURE EXPOSURE IS 260°C FOR 10 SECONDS.
2. LEADS ARE FOR TESTING ONLY AND MAY BE TRIMMED FLUSH.
3. DIMENSIONS ARE SPECIFIED IN INCHES
4. TOLERANCES: xx ±.01
xxx ±.005

Case Drawings TC-1

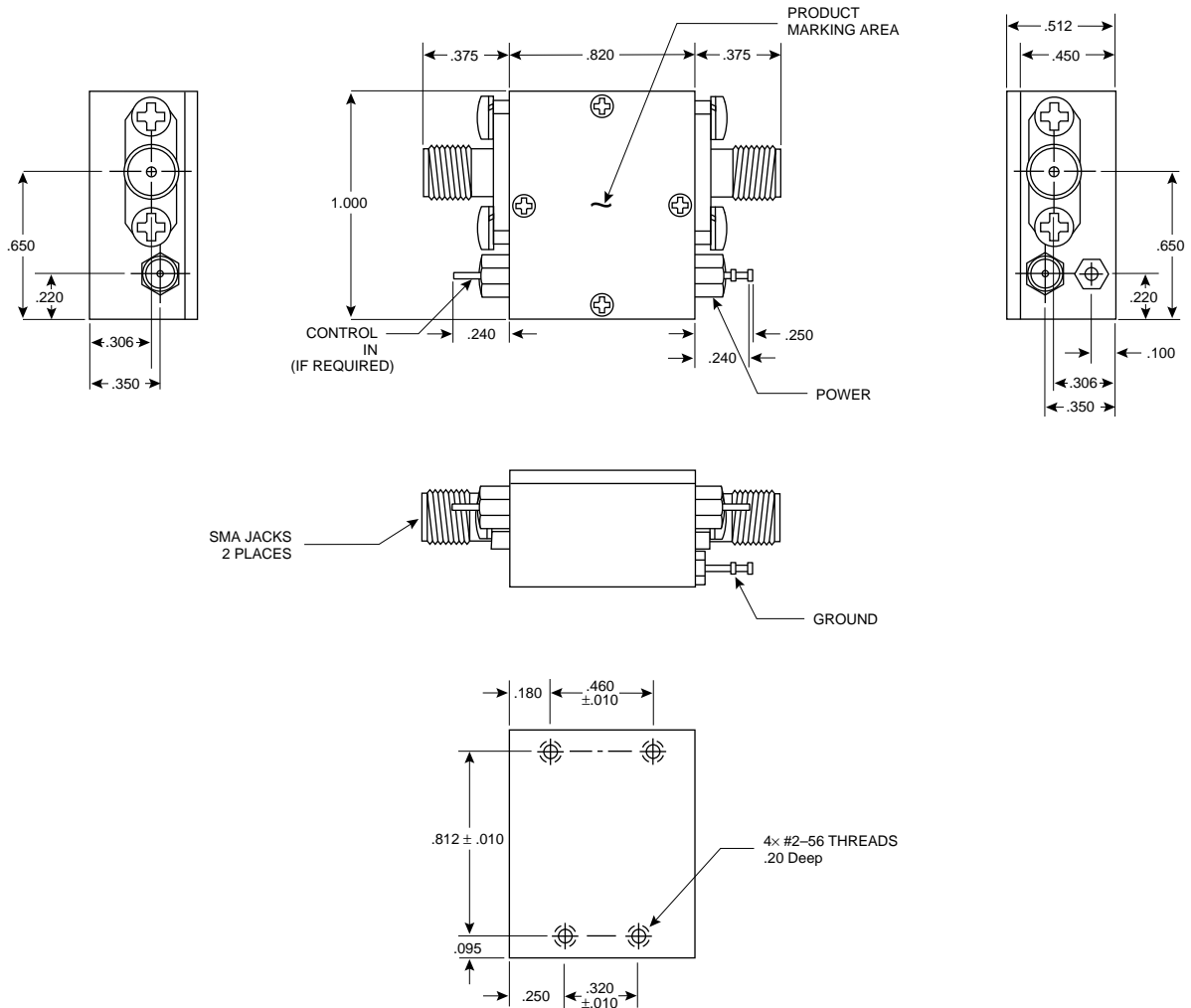

NOTES (UNLESS OTHERWISE SPECIFIED):

1. MATERIAL AL ALY 6061-T6
2. FINISH CHEM FILM PER MIL-G-5541C CLASS 3 COLOR-GOLD
3. BREAK ALL SHARP EDGES & CORNERS & GRIND SMOOTH

Contact Teledyne Microwave Solutions:
650-691-9800
650-962-6845 fax

Check for updates:
www.teledynemicrowave.com