



Thin-Film Cascadable Amplifier 10 to 2000 MHz

Technical Data

UTO/UTC/PSA 2009 Series

Features

- **Low Distortion:**
 $IP_3 = +40 \text{ dBm (Typ)}$
- **Frequency Range: 10 to 2000 MHz**
- **High Power Output:**
 $+28 \text{ dBm (Typ)}$
- **Low Noise Figure:**
 3.5 dB (Typ)
- **Medium Gain: 11.5 dB (Typ)**

Applications

- **IF/RF Amplification**
- **Output or Driver Stage**
- **Instrumentation**

Description

The 2009 Series is a thin-film GaAs FET RF amplifier for high output power and low noise applications up to 2000 MHz. Low VSWR is maintained by resistive feedback and inductive tuning while the RF is coupled through the amplifier by internal blocking capacitors. The 2009 Series amplifiers are available in the TO-8, SM-45 hermetic cases or connected TC-1A package.

Pin Configuration

UTO—TO-8T

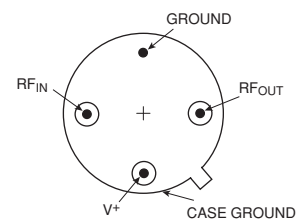

PSA—SM-45

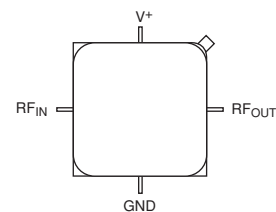

UTC—TC-1A

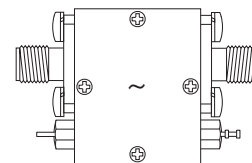

Schematic

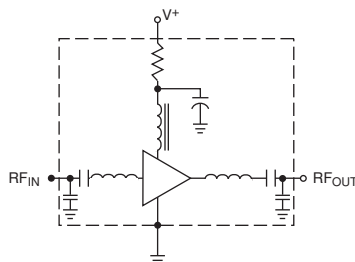

Maximum Ratings

Parameter	Maximum
DC Voltage	+17 Volts
Continuous RF Input Power	+27 dBm
Operating Case Temperature	-55 to +85°C
Storage Temperature	-62 to +150°C
"R" Series Burn-In Temperature	+85°C

Thermal Characteristics

θ_{JC}	39°C/W
Active Transistor Power Dissipation	2.28 W
Junction Temperature Above Case Temperature	89°C
MTBF (MIL-HDBK-217F, A_{UF} @ 75°C)	638,175 Hrs.
T_{CH} Max.	175°C

Weight: (typical) UTO—2.1 grams; SM-45—1.7 grams; UTC—21.5 grams

Electrical Specifications

(Measured in 50 Ω system @ +15 VDC nominal unless otherwise noted)

Symbol	Characteristic	Typical $T_C = 25^\circ\text{C}$	Guaranteed Specifications		Unit
			$T_C = 0$ to 50°C	$T_C = -55$ to $+85^\circ\text{C}$	
BW	Frequency Range	10–2000	10–2000	10–2000	MHz
GP	Small Signal Gain (Min.)	11.5	10.5	10.0	dB
—	Gain Flatness (Max.)	± 0.5	± 1.0	± 1.0	dB
NF	Noise Figure (Max.)	3.5*	4.0*	4.5*	dB
P_{1dB}	Power Output @ +1 dB Comp. (Min.)	+28.0	+26.5	+26.0	dBm
—	Input VSWR (Max.)	2.0:1	2.2:1	2.2:1	—
—	Output VSWR (Max.)	1.7:1	2.2:1	2.2:1	—
IP_3	Two Tone 3rd Order Intercept Point	+40.0	—	—	dBm
IP_2	Two Tone 2nd Order Intercept Point	+60.0	—	—	dBm
HP_2	One Tone 2nd Harmonic Intercept Point	+65.0	—	—	dBm
I_D	DC Current	190	—	—	mA

* Specification applies at F greater than 100 MHz; NF @ 10 MHz = 8 dB typical.

Typical Performance Over Temperature (@ +15 VDC unless otherwise noted)

Key: +25°C —
+85°C —
-55°C —

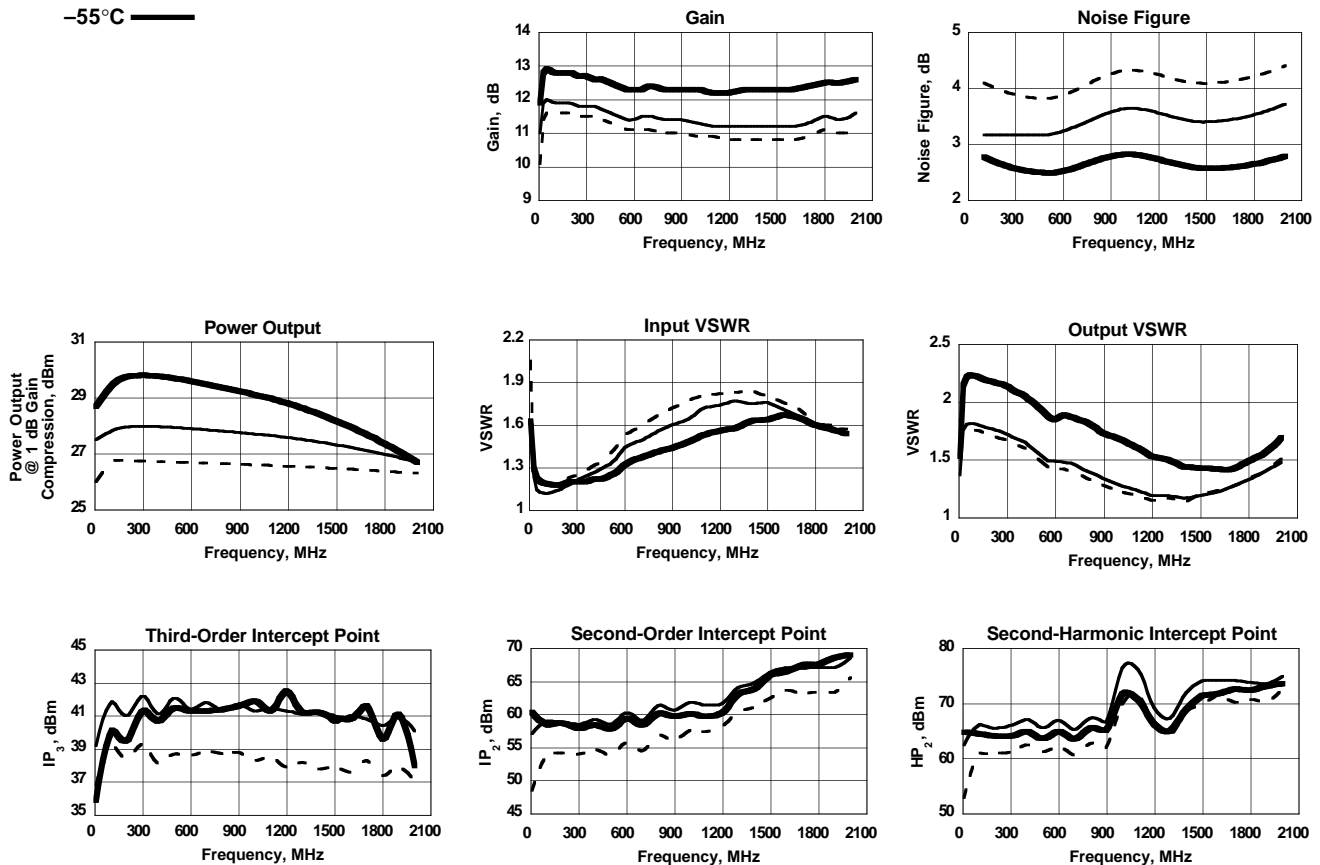

Automatic Network Analyzer Measurements (Typical production unit @ 25°C ambient)
S-Parameters **Bias = 15.00 Volts**

FREQ MHz	S ₁₁		S ₂₁		S ₁₂		S ₂₂		GPDEL ns	PHASE DEV
	Mag	Ang	dB	Ang	dB	Ang	Mag	Ang		
5.0	0.361	-56.2	9.964	-141.7	-17.487	21.0	0.239	139.4	9.66	
10.0	0.220	-73.1	11.353	-159.1	-18.129	2.3	0.183	-169.2	6.80	15.84
15.0	0.161	-83.2	11.769	-166.1	-18.750	-1.9	0.241	-166.0	3.15	9.36
20.0	0.129	-90.7	11.939	-170.4	-19.046	-3.2	0.267	-168.9	2.01	5.71
25.0	0.108	-96.6	12.033	-173.4	-19.228	-3.5	0.281	-171.5	1.42	3.32
30.0	0.096	-101.1	12.078	-175.5	-19.379	-3.6	0.289	-173.6	1.04	1.78
35.0	0.086	-105.1	12.113	-177.1	-19.448	-3.8	0.294	-175.5	0.87	.78
40.0	0.080	-108.4	12.127	-178.6	-19.520	-3.9	0.297	-177.2	0.79	-.17
45.0	0.075	-111.0	12.127	-179.9	-19.537	-4.1	0.298	-178.4	0.69	-.88
50.0	0.072	-113.5	12.164	178.9	-19.595	-4.1	0.300	-179.5	0.48	-1.46
100.0	0.062	-124.7	12.163	170.6	-19.671	-6.5	0.302	172.4	0.42	-3.83
150.0	0.066	-125.2	12.130	163.9	-19.684	-9.2	0.297	166.4	0.36	-4.59
200.0	0.073	-126.0	12.099	157.6	-19.697	-12.0	0.292	160.9	0.34	-4.93
250.0	0.083	-126.1	12.049	151.5	-19.701	-15.1	0.286	155.7	0.33	-5.07
300.0	0.093	-125.5	12.021	145.5	-19.711	-17.7	0.279	150.7	0.33	-5.05
350.0	0.103	-126.3	11.974	139.8	-19.742	-20.3	0.271	145.7	0.32	-4.86
400.0	0.113	-126.9	11.913	134.0	-19.773	-23.1	0.261	140.4	0.32	-4.72
450.0	0.124	-127.2	11.818	128.2	-19.704	-26.0	0.250	134.9	0.32	-4.49
500.0	0.134	-127.2	11.716	122.5	-19.665	-29.2	0.236	130.1	0.29	-4.27
600.0	0.171	-130.9	11.613	112.7	-19.622	-36.8	0.212	126.0	0.29	-2.14
700.0	0.190	-138.8	11.663	101.4	-19.832	-42.7	0.206	115.6	0.32	-1.62
800.0	0.207	-144.4	11.619	90.0	-19.905	-48.5	0.189	104.1	0.31	-1.08
900.0	0.221	-149.7	11.542	78.7	-19.935	-53.9	0.169	91.8	0.31	-.44
1000.0	0.233	-155.1	11.476	67.6	-19.921	-60.8	0.150	79.4	0.31	.35
1100.0	0.245	-161.0	11.437	56.5	-19.929	-67.1	0.132	64.3	0.31	1.11
1200.0	0.253	-167.3	11.395	45.2	-19.926	-73.9	0.120	49.7	0.31	1.79
1300.0	0.259	-174.1	11.353	34.1	-19.904	-80.3	0.110	32.0	0.31	2.56
1400.0	0.261	178.1	11.388	22.6	-19.868	-87.2	0.108	15.0	0.32	2.96
1500.0	0.260	169.2	11.420	10.8	-19.828	-94.5	0.108	-1.5	0.33	3.05
1600.0	0.255	158.5	11.461	-1.2	-19.806	-102.6	0.117	-15.8	0.34	2.95
1700.0	0.248	145.5	11.544	-13.7	-19.676	-110.9	0.129	-26.6	0.36	2.33
1800.0	0.239	128.6	11.614	-27.0	-19.602	-119.8	0.149	-37.0	0.38	.94
1900.0	0.233	107.4	11.715	-41.0	-19.539	-130.0	0.174	-43.8	0.40	-1.15
2000.0	0.242	81.1	11.761	-55.8	-19.557	-140.7	0.210	-52.5	0.45	-4.07
2200.0	0.342	22.9	11.510	-89.6	-19.859	-166.0	0.310	-72.2	0.50	
2400.0	0.542	-25.7	10.318	-127.2	-21.279	165.7	0.422	-99.0	0.52	
2600.0	0.722	-63.5	7.688	-164.2	-24.290	139.6	0.473	-129.6	0.47	
2800.0	0.823	-92.0	4.005	164.9	-28.185	125.0	0.439	-158.0	0.37	
3000.0	0.867	-113.3	-.132	142.2	-32.202	122.9	0.353	178.2	0.32	

LINEARIZATION RANGE: 10.0 to 2000.0 MHz

Product Options

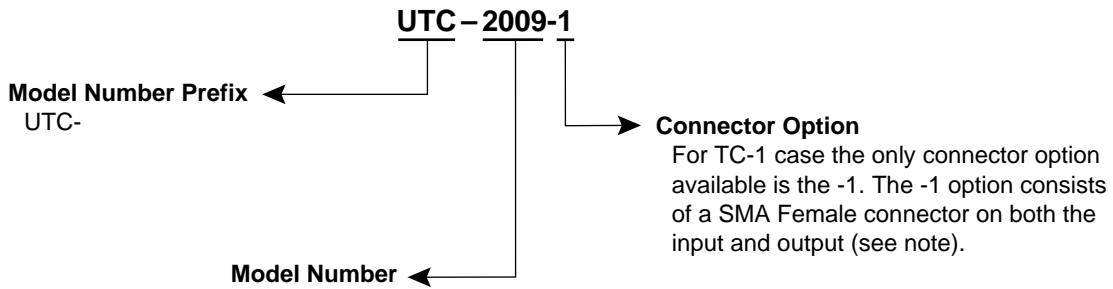
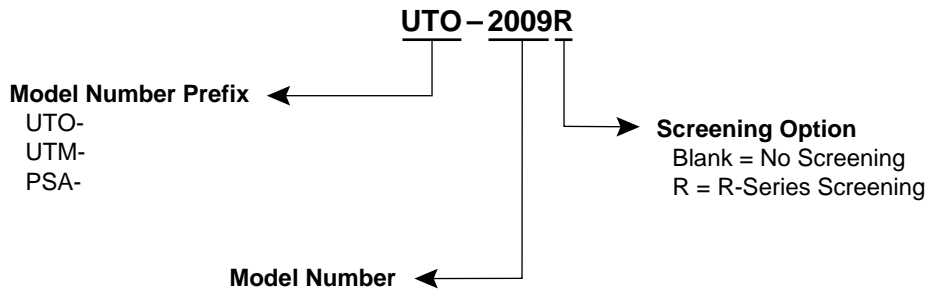

Note: R-Series screening is not available in the TC-1 case as the case is non-hermetic.

**Case Drawings
TO-8T**

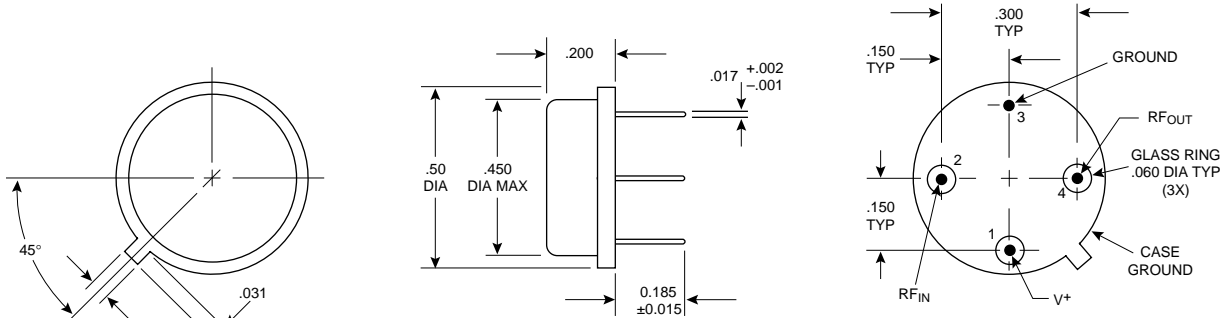

APPROXIMATE WEIGHT 2.1 GRAMS

- NOTES (UNLESS OTHERWISE SPECIFIED):**
 1. DIMENSIONS ARE SPECIFIED IN INCHES
 2. TOLERANCES: xx ±.02
 xxx ±.010

SM-45

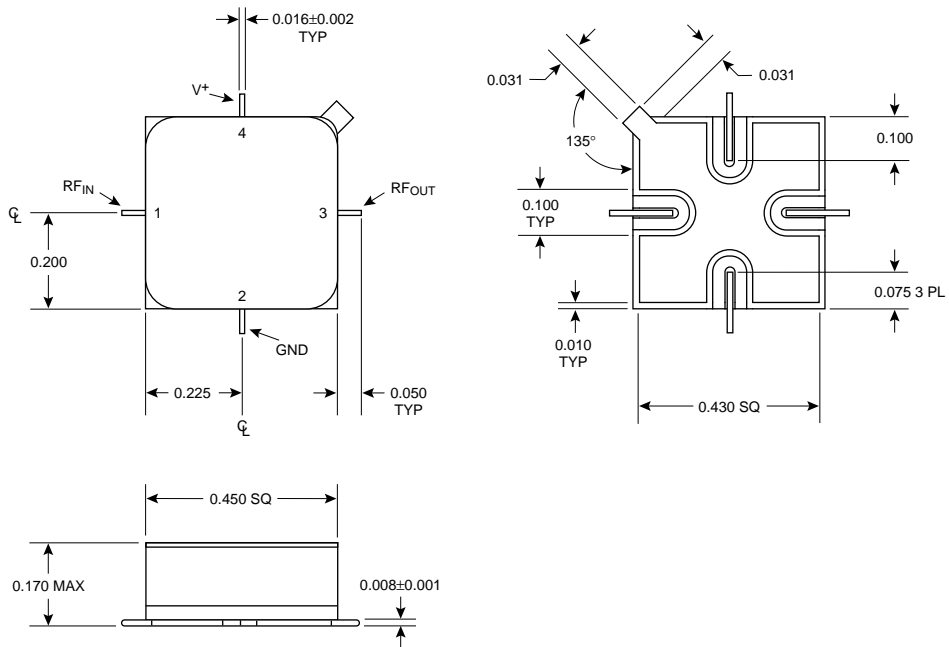

APPROXIMATE WEIGHT 1.7 GRAMS TYPICAL

- NOTES (UNLESS OTHERWISE SPECIFIED):**
 1. MAXIMUM TEMPERATURE EXPOSURE IS 260°C FOR 10 SECONDS.
 2. LEADS ARE FOR TESTING ONLY AND MAY BE TRIMMED FLUSH.
 3. DIMENSIONS ARE SPECIFIED IN INCHES
 4. TOLERANCES: xx ±.01
 xxx ±.005

Case Drawings TC-1

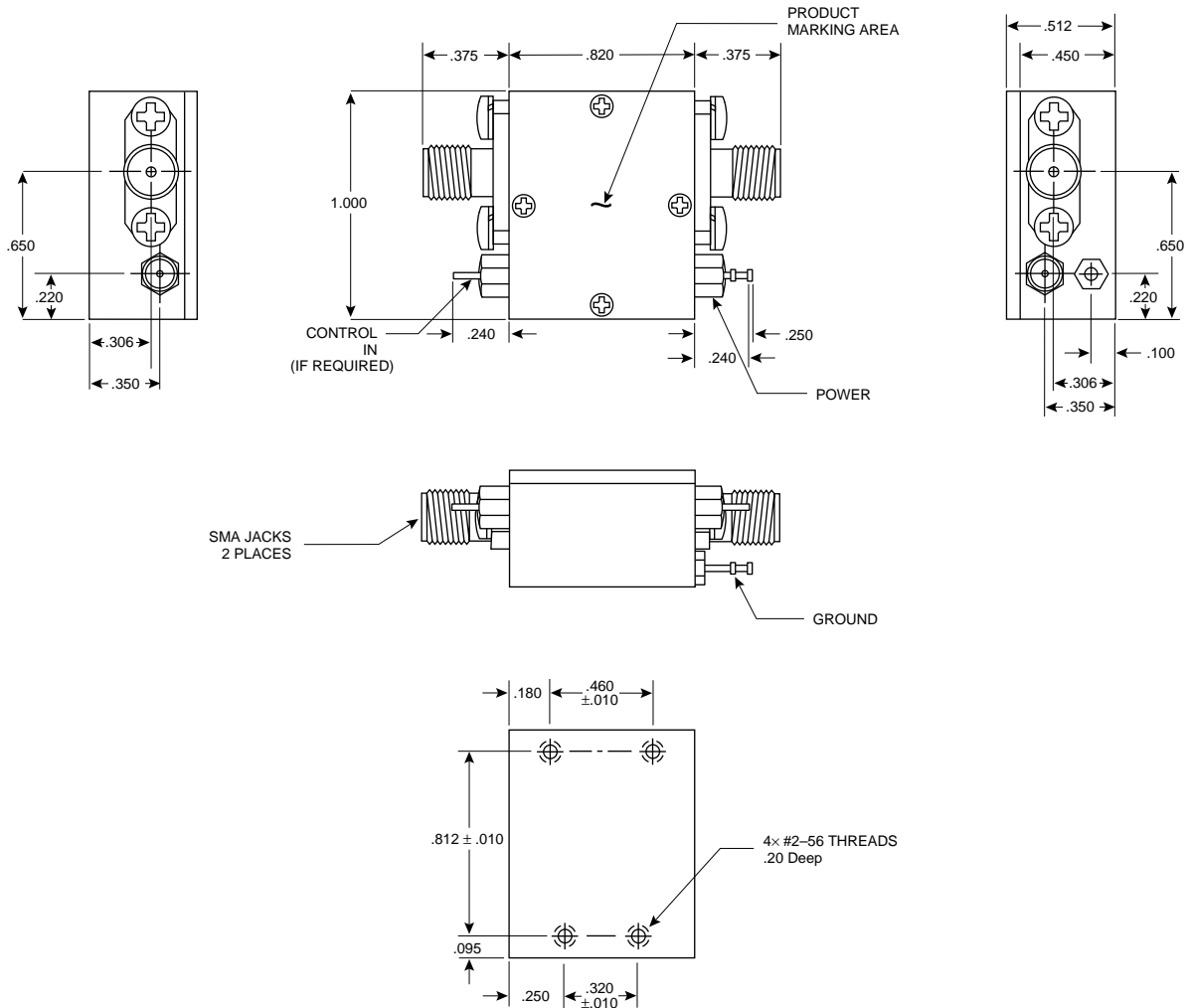

NOTES (UNLESS OTHERWISE SPECIFIED):

1. MATERIAL AL ALY 6061-T6
2. FINISH CHEM FILM PER MIL-G-5541C CLASS 3 COLOR-GOLD
3. BREAK ALL SHARP EDGES & CORNERS & GRIND SMOOTH

Contact Teledyne Microwave Solutions:
650-691-9800
650-962-6845 fax

Check for updates:
www.teledynemicrowave.com