

### Miniature Front End Radar Warning Receiver

The RR009 is designed for Radar Warning Receiver (RWR) applications where small size and low power consumption are of prime importance, with filtering, amplification, detection and frequency measurement being combined into one multi-function unit.

The RR009 brings RWR protection to platforms where it was previously unavailable for reason of cost or size. Two amplitude measurement channels allow direction finding by amplitude comparison between adjacent antennas. A two-tier discriminator, fed from one of the amplitude channels via an SPDT switch, performs 6 bits of frequency measurement on the selected input. Frequency resolution is nominally 156 MHz over an 8 to 18 GHz band.

RF connections are made by SSMA, power and data use miniature Omnetics nano connectors.

The ultra-small size eases the burden on UAV and light vehicle payloads in particular and the low power consumption renders a double benefit, as a smaller, lighter power supply is required.

The RR009 is the leader of a family of products. Development is under way in realising extended frequency and logging range. Please contact the Sales Dept with your specific requirement.

#### FEATURES

- Frequency range 8 to 18 GHz
- Video O/P Tss -73dBm
- 40dB logging range
- -63dBm frequency measurement capability
- 6 bit frequency resolution
- Extremely small form factor
- Low power consumption 3W
- Standby Mode

#### APPLICATIONS

- Radar Warning Receiver (RWR) for:
  - Personnel
  - UAV
  - AFV
  - Remote sensing
- Affordable RWR for air, sea and land platforms

See restrictions on published datasheets at [www.teledynedefence.co.uk/](http://www.teledynedefence.co.uk/)

## Electrical Specification - M3 variant. -20°C to +50°C

Operating Frequency	8 to 18 GHz
Out of Band Rejection	DC to 7 GHz > 60 dB 20 to 26 GHz > 30 dB
Operating Dynamic Range for Video Output	-73 to 0dBm Operating Dynamic Range for Frequency Measurement -63 to 0dBm
Frequency Measurement Coding	8000+156.25xCode MHz
Frequency Measurement Resolution	6 bits 156.25 MHz nom.
Frequency Measurement Accuracy	<200 MHz r.m.s.
Minimum Pulse Width	100 ns
Frequency Measurement Triggering	External Latch Input
Latch to Data Valid Delay	70 ns max.
Video Tangential Signal Sensitivity (8 dB Video SNR)	-73 dBm
Video Output Logging Range	-70 to -30 dBm
Video Output Frequency Flatness Same Frequency and Temperature)	±2.5 dB Amplitude Tracking (Between any video outputs at the ±1 dB Typical
Video Output Rise Time at Ambient Temperature	70 ns
Video Output Slope	50 mV/dB
Logging Linearity over logging range	±1 dB
Video Coupling	Active d.c. restored
Maximum RF Input Duty Cycle	50 %
RF Input Switch Isolation. Inputs 1-2 and A-B	25 dB min
RF Input Switch Speed	<5 µs
RF Input Switch Control	TTL
Input Return Loss, Ports A1,A2,B1,B2	7dB min (10dB typ)
J1 & J2 Power Supply Current (operating - no RF)	+6 V at 50 mA -6 V at 50 mA
M3 version See note on page 5 for other variants	+3 V at 130 mA
J3 Power Supply Current (operating - no RF)	+6 V at 170 mA
M3 version See note on page 5 for other variants	-6 V at 20 mA
J1 & J2 Power Supply Current (standby)	+6 V at 50 mA
M3 version. See note on page 5 for other variants	-6 V at 50 mA +3 V at 0 mA
J3 Power Supply Current (standby)	+6 V at 120 mA
See note on page 5 for other variants	-6 V at 20 mA
Total Power Dissipation (operating - no RF)	3.1 Watts typ
Total Power Dissipation (standby)	2 Watts typ
Power-up Time (standby to on)	<100 µs
Power-up Time (cold start)	<30ms
Temperature Range	-20°C to +50°C
Dimensions	114.5x 62.85 x 14.05mm
Weight	200 grams
Microwave Input Connectors	SSMA Female
Power and control	Omnetics single row receptacle
External Finish	Gold Flash over Nickel
Environmental Specification	Epoxy sealed RF conformally coated pcb. 95% humidity. AUF environment.

See restrictions on published datasheets at [www.teledynedefence.co.uk/](http://www.teledynedefence.co.uk/)

### BLOCK DIAGRAM

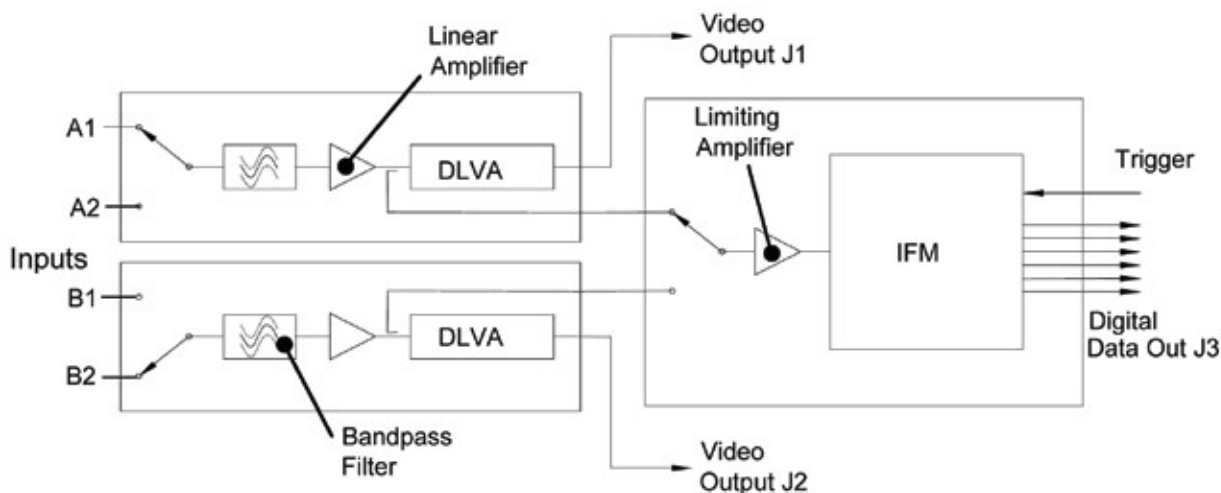

### TIMING

When RF enters the discriminator circuits, the video voltages settle after a delay of approx 80ns. Digitisation is initiated by the rising edge of the external latch input, the 6 bit frequency word is valid after 70ns.

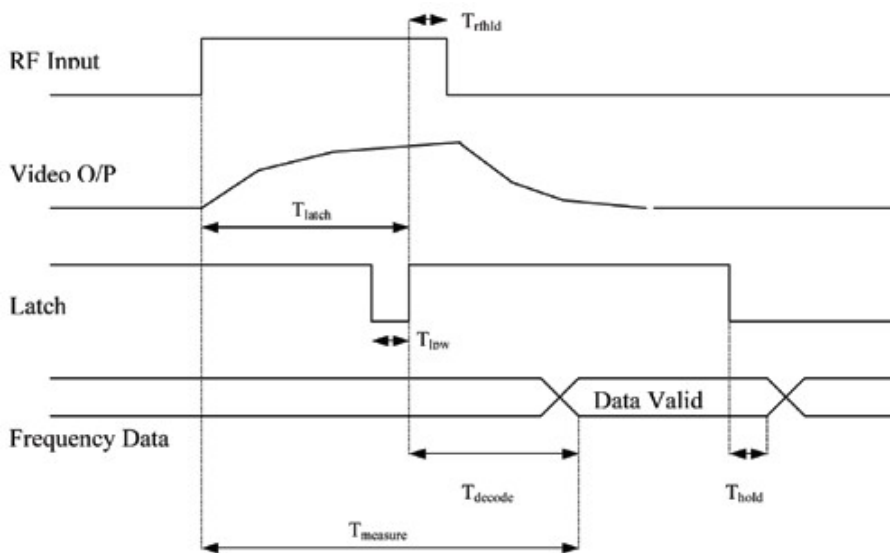

Description	Symbol	Min	Max	Unit
Rising edge of latch to trailing edge of RF	trfhld	6		ns
Width of latch pulse	tlpw	5		ns
Rising edge of latch to data valid	Tdecode		70	ns
Data hold time	thold		17	ns
Leading edge of RF to valid frequency out	tmeas	150		ns

See restrictions on published datasheets at [www.teledynedefence.co.uk/](http://www.teledynedefence.co.uk/)

Typical Performance Data at +25C

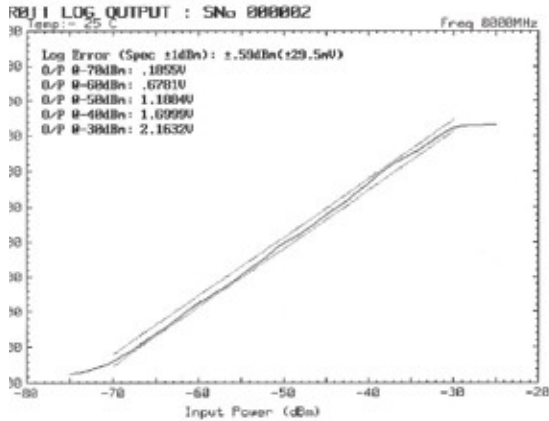

Log plot at 8 GHz

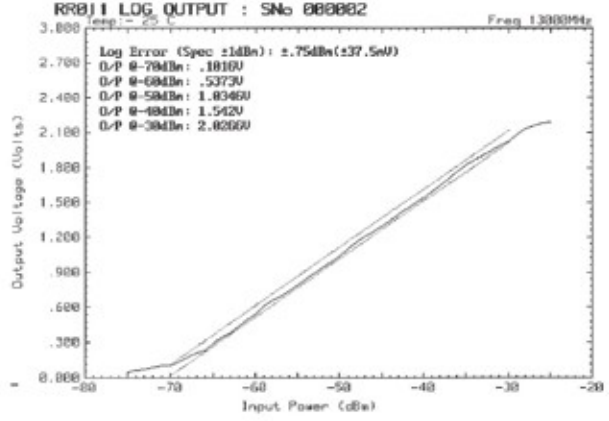

Log plot at 13 GHz

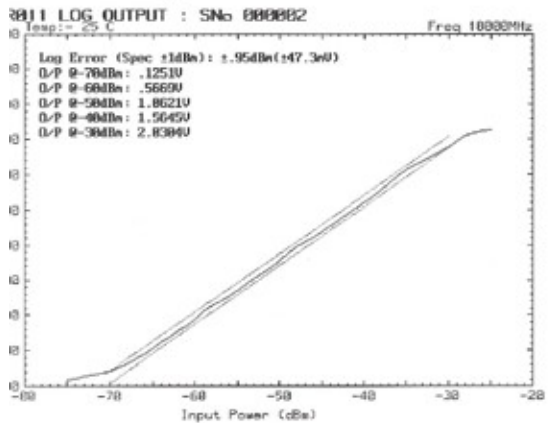

Log plot at 18 GHz

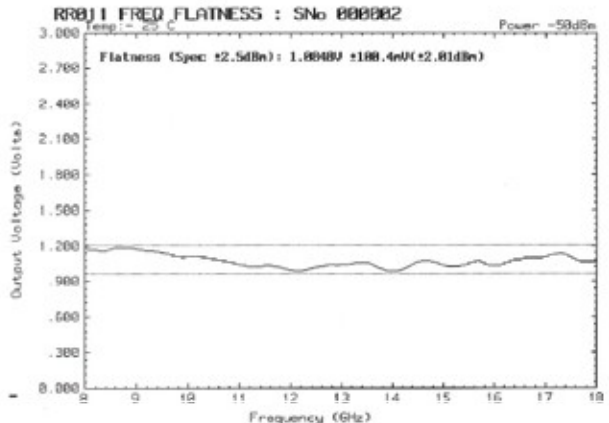

Frequency Flatness at -50dBm input

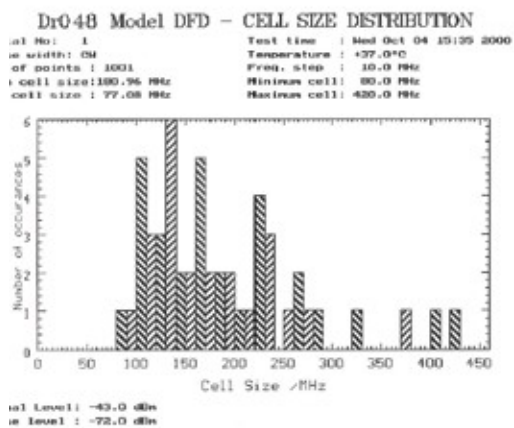

Cell size distribution

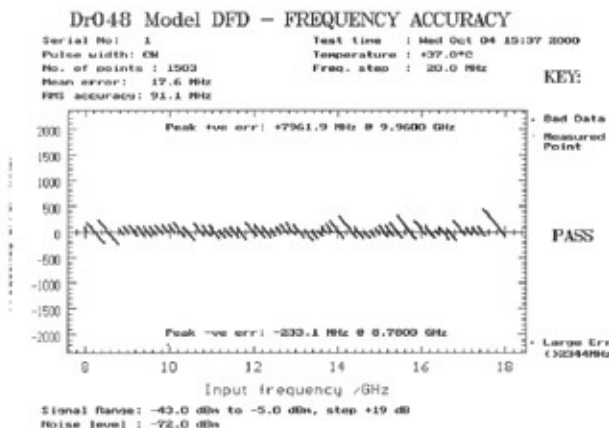

Frequency accuracy

See restrictions on published datasheets at [www.teledynedefence.co.uk/](http://www.teledynedefence.co.uk/)

## CONNECTOR INFORMATION

### Amplitude Module Connectors J1 & J2

The Amplitude Measurement Module connector is a 9 way Omnetics® single row receptacle. The mating part is a 9 way single row plug with wire leads. Example part number: A9725

Pin	Type	Signal
1	POWER	
2	POWER	+3V (optional amplifier bias)
3	IN TTL	Input Select. High= Input 1
4	IN TTL	Standby (active low)
5	POWER	-6V
6	RESERVED	Do Not Connect
7	GND	Ground
8	OUTPUT	Video Output
9	GND	Ground

### Frequency Module Connector J3

The Frequency Measurement Module connector is a 15 way Omnetics® single row receptacle. The mating part is a 15 way single row plug with wire leads. Example part number: A9726

Pin	Type	Signal
1	POWER	+6V
2	POWER	+6V
3	POWER	-6V
4	IN TTL	Input Select. High = Inputs B
5	OUT TTL	D0
6	OUT TTL	D1
7	OUT TTL	D2
8	OUT TTL	D3
9	OUT TTL	D4
10	OUT TTL	D5
11	RESERVED	Do Not Connect
12	IN TTL	Latch
13	IN TTL	Standby (active low)
14	POWER	GND
15	POWER	GND

#### Note:

The microwave amplifiers in the amplitude modules may be biased in three factory configurations. Specify the required configuration when ordering e.g. RR009-M3.

**M1** The bias can be internally developed using a switching power supply which degrades sensitivity but has advantages of reduced power consumption and ease of interface, +6V @ 130mA J1 and J2.

**M2** The bias can be internally developed using a linear regulator for optimum sensitivity and ease of interface at the cost of increased power consumption. +6V @ 180mA J1 and J2.

**M3** The bias can be directly supplied as +3V for optimum sensitivity and lowest power dissipation. +6V @ 50mA, +3V @ 130mA J1 & J2.

See restrictions on published datasheets at [www.teledynedefence.co.uk/](http://www.teledynedefence.co.uk/)

OUTLINE DRAWING

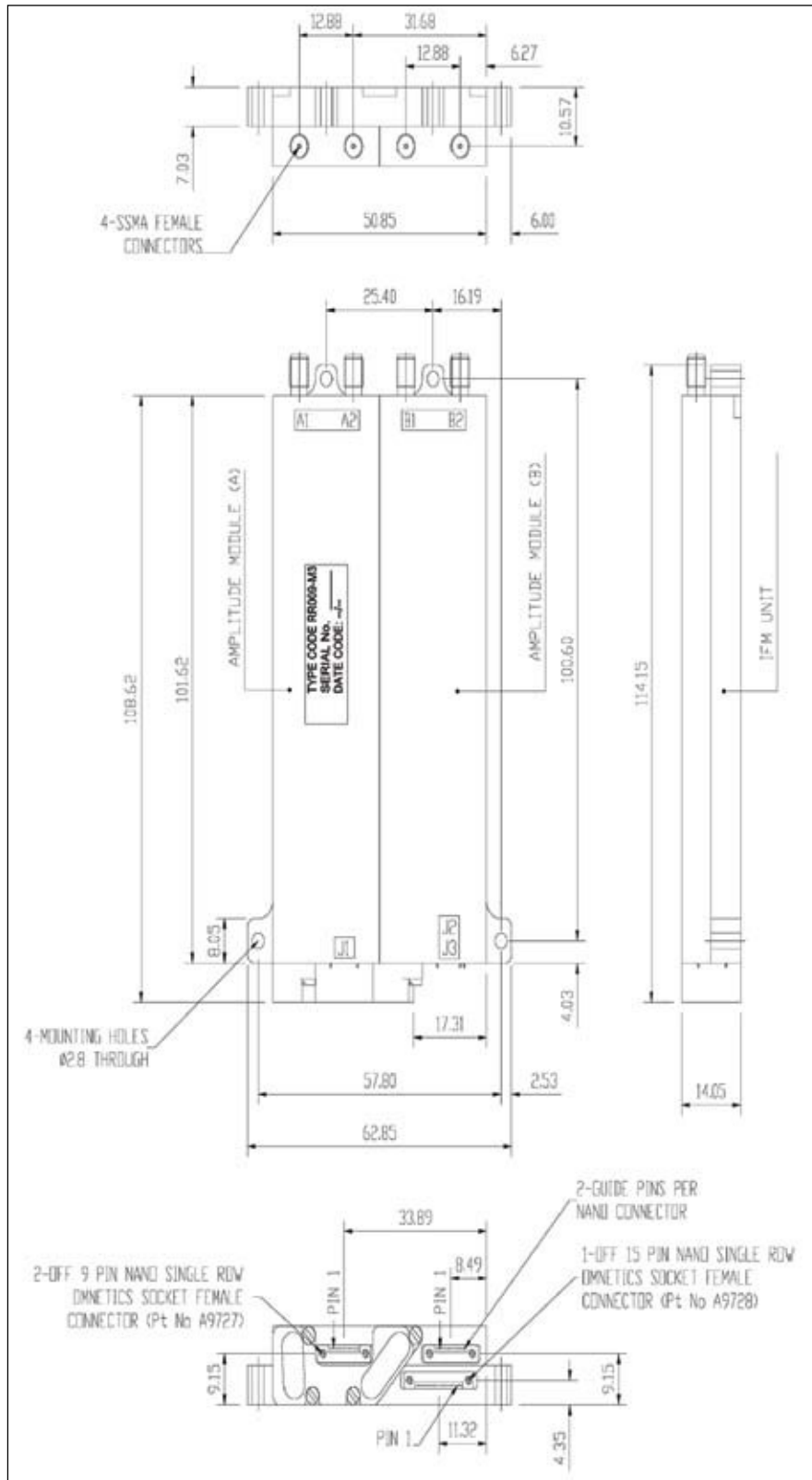

See restrictions on published datasheets at [www.teledynedefence.co.uk/](http://www.teledynedefence.co.uk/)