

## 0.5 - 18GHz Switch Multiplexer

The Switch Multiplexer is a single RF input to single RF output, fast, multi-configurable filter bank covering 0.5 - 18GHz.

Consisting of 17 channels (0.5 - 18GHz), these are equally spaced 1GHz channels. Each channel is independently controlled, allowing 131072 possible combinations of overall filter response from input to output. In addition 9 tap out ports, split into 2GHz wide bands, are provided for monitoring purposes should this be required. In normal operation these are terminated in 50ohm loads.

This provides the user with a fast, flexible, filter network capable of providing different band-pass or band-stop responses on a pulse-by-pulse basis in dense signal environments.

Filter control is achieved by 17 bit parallel low voltage TTL on VME control bits.

With internal amplification, providing zero loss and low noise figure, together with flat insertion loss and exceptionally flat group delay, the filter is an ideal system enhancement.

Designed to withstand harsh military environments, the SA004 is a complete front-end filter solution allowing system designers to achieve functionality previously unattainable.

### FEATURES

- Full 0.5 – 18GHz
- 17 Channels
- Low Noise Figure

### APPLICATIONS

- Broadband EW Signal limiting
- Adaptive filtering
- RWR system protection
- Test lab filtering

See restrictions on published datasheets at [www.teledynedefence.co.uk/](http://www.teledynedefence.co.uk/)

### SPECIFICATIONS

Parameter	Specification
Frequency	0.5 to 18GHz
Noise Figure across selected passbands :	(3.0-18.0)GHz 11dB max (0.5-3.0)GHz 16dB max
Input p1dB	>0dBm
No of Channels	17
Channel Crossovers	0.5-2-3-4-5-6-7-8-9-10-11-12-13-14-15-16-17-18GHz
Band width reduction	When channels are deselected band edges reduce: 0.5 - 8GHz +/-250MHz 8 - 12GHz +/-300MHz 12 - 18GHz +/-400MHz
Control	17 bit parallel LVTTTL on VME P2 connector
Insertion Loss Window	-2 to +2dB at ambient across selected channels
IL Window Variation Across Temp	<0.025dB/degC
Rejection	Band edge +/- 500Mhz >30dB Band Edge +/- 1GHz >50dB
VSWR	Input 2.5:1
Temperature	-40 to +85 deg C
DC Power	+5V 750mA max -12V 100mA max

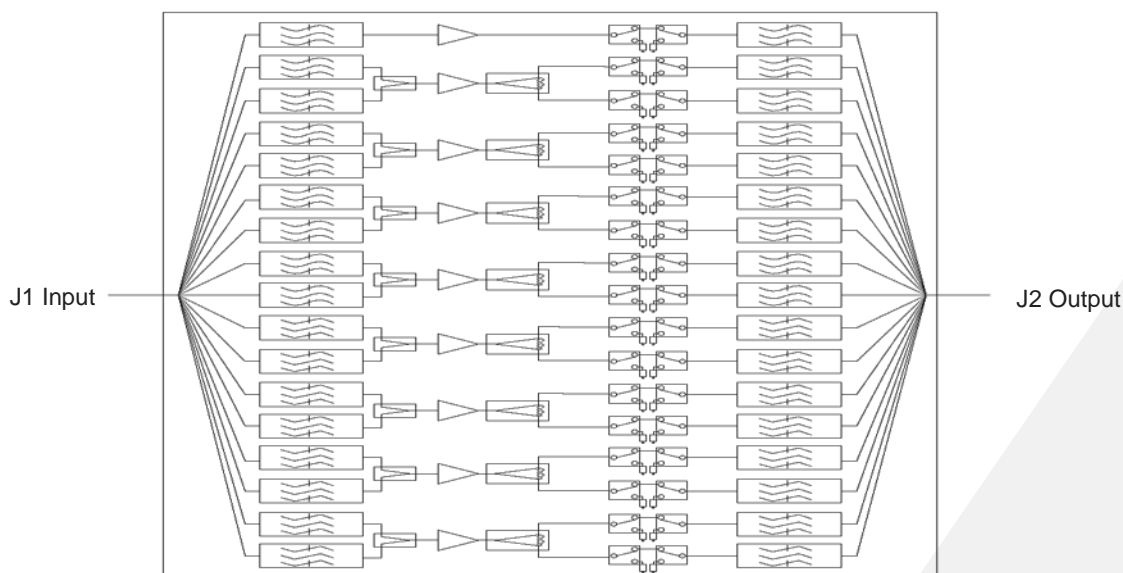

See restrictions on published datasheets at [www.teledynedefence.co.uk/](http://www.teledynedefence.co.uk/)

PERFORMANCE DATA

Insertion Loss and Rejection

The following plots show the filter in differing states, showing the true switch multiplexer nature of the SA004.

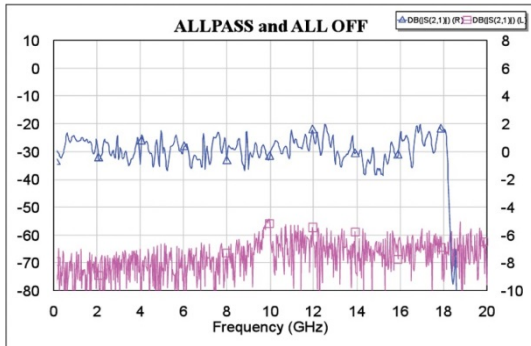

Fig 1. S21, All pass and all 'OFF'

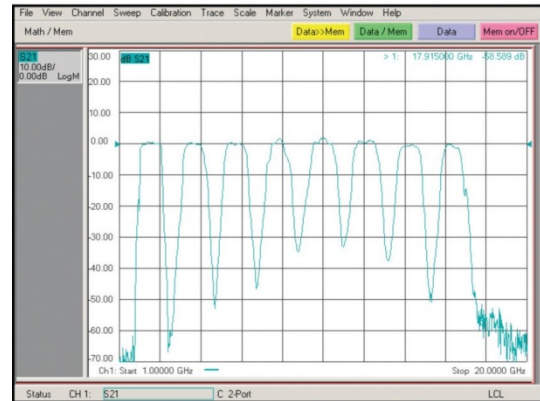

Fig 2. S21, ODD channels 'ON'

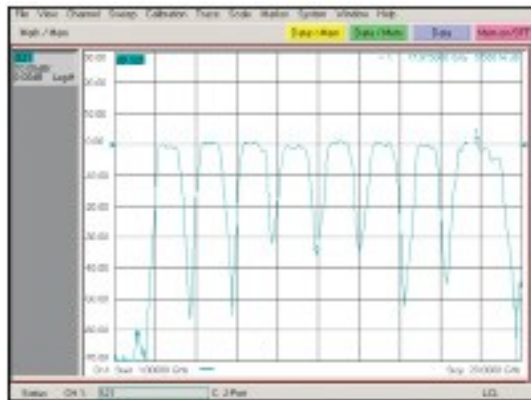

Fig 3. S21, EVEN channels 'ON'

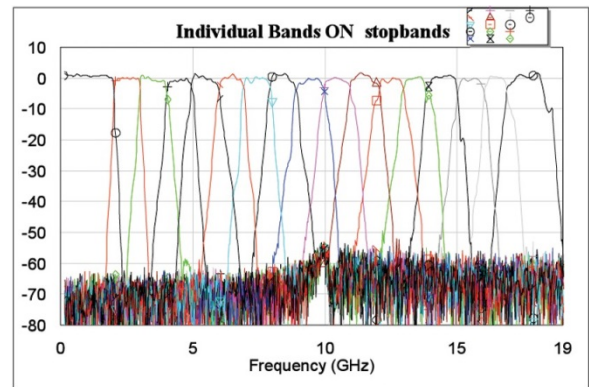

Fig 4. S21, Overlay of individual channels

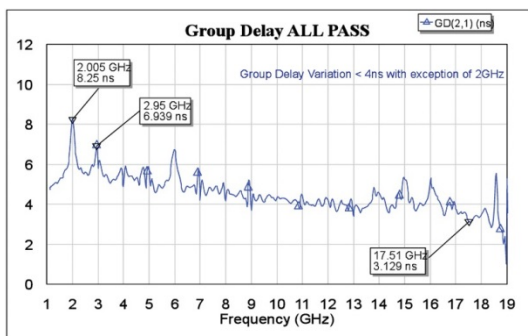

Fig 5. S21, Group Delay

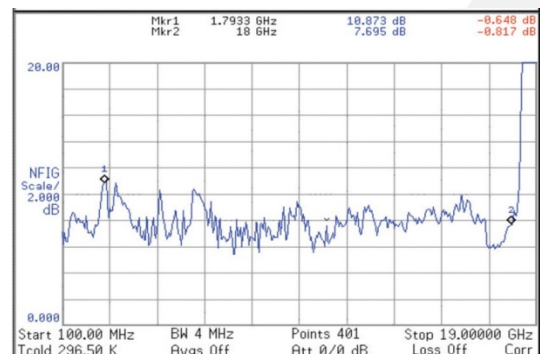

Fig 6. All Pass Noise Figure

See restrictions on published datasheets at [www.teledynedefence.co.uk/](http://www.teledynedefence.co.uk/)