

NOTES:

1. FEATURES SUCH AS TAPPED HOLES, SCREW HEADS AND COVER DETAILS ARE OMITTED FOR CLARITY.
2. WEIGHT: 9.0 Lbs MAXIMUM.  
4.1 Kg MAXIMUM.
3. OPTIONAL (N.C./N.O.)
4. REFER TO OUTLINE 0129045.

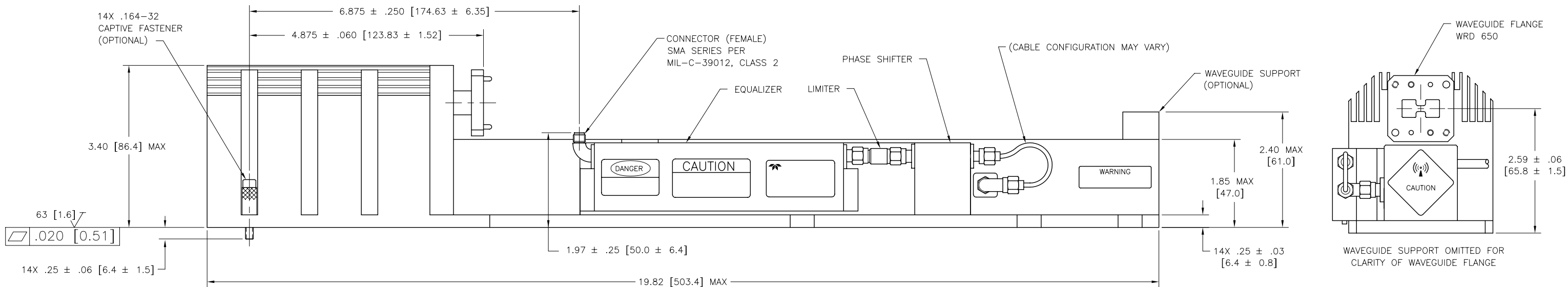
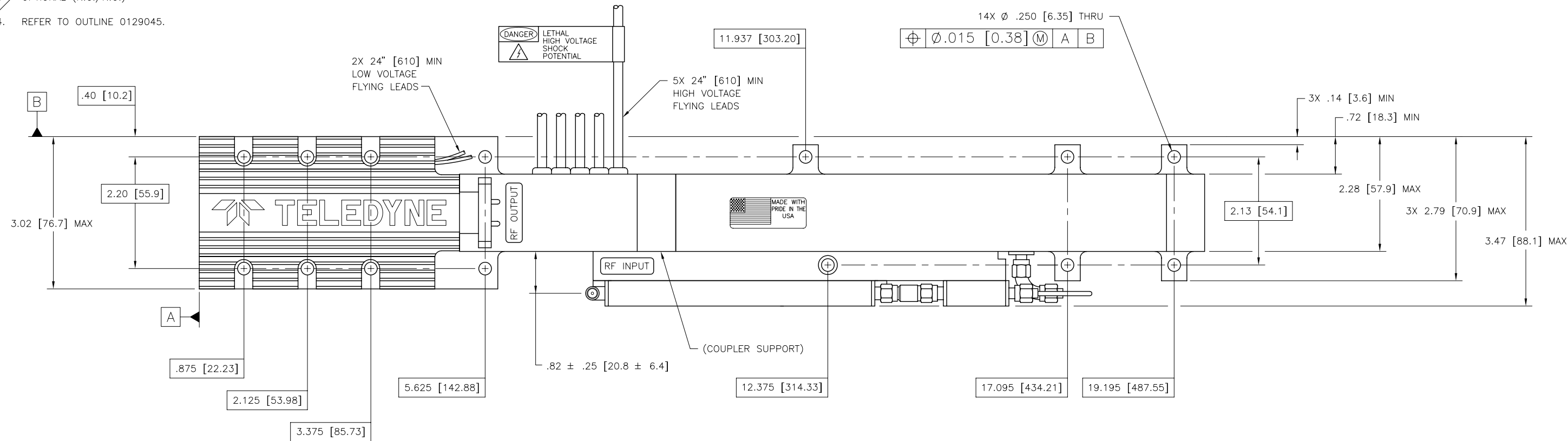

HIGH VOLTAGE CONNECTIONS	
FUNCTION	COLOR
HEATER	BROWN
CATHODE	YELLOW
CONTROL ELECTRODE	GREEN
COLLECTOR #1	RED
COLLECTOR #2	WHITE

LOW VOLTAGE CONNECTIONS	
FUNCTION	COLOR
HELIX/GROUND	BLACK
THERMOSTAT	GRAY

3

SUBJECT TO CHANGE W/O NOTICE

ISO 9001:2000 Registered

DO NOT SCALE DRAWING  
UNLESS OTHERWISE NOTED  
DIMENSIONS ARE IN INCHES  
TOLERANCES ON  
DECIMALS ANGLES  
.XX ± .02 .XXX ± .005 ± 2°  
REMOVE ALL BURRS AND SHARP EDGES  
SURFACE ROUGHNESS PER  
ASA B46.1  
DIM AND TOL IAW  
ASME Y14.5M - 1994

**TELEDYNE MEC**  
11361 Sunrise Park Dr., Rancho Cordova, CA (916) 638-3344

TITLE  
**OUTLINE DRAWING**  
MEC 5423 (GRID)  
MEC 5424 (FE)